



880MP Series Nonmetallic Floor Boxes

Modulink™ 880 Series Nonmetallic Floor Boxes provide power and communication services directly to the workstation or to any open space location. The Modulink Floor Box is a gangable box that allow a one-gang floor box to easily be turned into a two- or three-gang box simply by ganging together individual boxes. This floor box has many applications including commercial offices, retail stores, malls, financial and government institutions.

Single-gang Modulink 880 Series Nonmetallic Floor Box can be ganged together to become two- or three-gang boxes to provide multiple services.

Features & Benefits

- **Multiple service capability.** Eliminates the cost of a separate floor box and cover to accommodate communication service.
- **Depth markings on exterior of the box.** Makes floor box depth calculations quick and easy. Reduces installation time and labor costs.
- **2" (51mm) conduit openings.** Provides the largest conduit feed in the industry. Meets customer requirements for greater communication cable capacity.
- **Ratchet adjusting ring.** Allows connection of cover flange without glue or mechanical fasteners. Reduces installation time and cost by providing 10° of post-pour adjustment of the cover flange.
- **Conduit reducers and plugs provided.** Allows direct reduction from 2" to 1 1/2" or 1 1/4" (51mm to 38mm or 32mm) conduit. Reduces installation time by providing direct reduction and separate plugs by eliminating the need to cut out plugs to form reducers.
- **Brushed aluminum covers for power applications.** 830CK Series Aluminum Covers have been redesigned to now accept threaded conduit when passing through power cables.
- **Brass and brushed aluminum covers to accept single locking power receptacles.** New 828DLR Series provides single flip lid cover.
- **Cubic inch markings on the interior of the box.** No need to calculate capacity for wire fill, saving installation time.
- **Ratchet adjusting ring has built-in fiber storage.** Provides bend radius control for fiber optic cables.
- **Pass-through capability.** Can feed multiple gangs from a single cable feed location. Reduces total installation time.
- **Modular design and gangability.** One SKU to order boxes with the ability to configure boxes as needed on the job site.
- **Internal spacer.** Protects box from deformation of the sidewalls when high temperature additives are used in the concrete pour.
- **Redesigned mudcap.** High impact mudcap protects the box from damage when heavy equipment such as scissor lift trucks come in contact with the box during installation.
- **TopGuard protection.** Activation covers for the 880MP PVC box are TopGuard protected. These cover assemblies keep out water, dirt, and debris from the power and communication compartments.
- **Communication connectivity options.** Accepts industry standard and proprietary devices from a wide range of manufacturers to provide a seamless and aesthetically pleasing interface for voice, data, audio, and video applications at the point-of-use. A wide selection of data and bezel options available for use with Ortronics® TracJack™ and Series II devices.

Vertical Markets

- Commercial
- Entertainment
- Retail
- Education
- Healthcare
- Government



Compliance

cULus Listed Nonmetallic Outlet Boxes. File E110748 Guide QCMZ.
Listed by Underwriters Laboratories Inc. to their standard UL514A, 514C, 514D, and Canadian standard C22.2.



Protection from water, dirt, and debris.

Modulink 880MP Series Floor Boxes Ordering Information

880MP

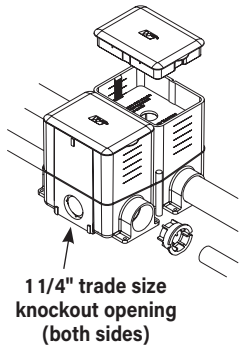

Nonmetallic Rectangular Floor Box – Box comes complete with reusable mudcap, insert spacer, conduit plugs and reducers. Reducers provided for reduction to 1", 3/4", and 1/2" (25mm, 19.1mm, and 12.7mm) conduit. Minimum concrete depth is 3 1/2" (89mm) and maximum concrete depth is 6" (152mm). Minimum capacity is 50 cu. in. (819ml) and maximum capacity is 100 cu. in. (1639ml). Box dimensions are 4 1/8" W x 5 1/2" L x 6" (105mm x 140mm x 152mm).

Country of Origin: USA

NOTE: Insert spacer should not be removed until after concrete pour.

NOTE: Box can be connected together to create a two- or three-gang option.

880MPA

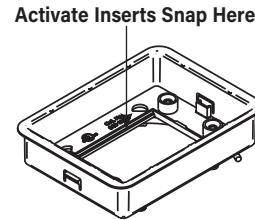

Nonmetallic Floor Box Adjusting Ring – Comes with fiber storage loop. Also includes brass inserts for flange connection and green ground wire for ground connection. Activate modular inserts snap directly into the adjusting ring without the need for a bezel. Also includes mounting screws to attach flange to box body. Ortronics® connectivity inserts do not snap directly into the adjusting ring. For Ortronics® inserts use the 828GFITC or 829PFLRT.

Country of Origin: USA

NOTE: One 880MPA is needed for each 880MP2 used. For example, a three-gang box will require three 880MPA Adjusting Rings (sold separately).

880MP2

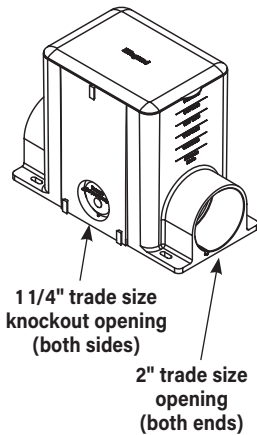

Nonmetallic Rectangular Floor Box – Box comes complete with reusable mudcap, insert spacer, conduit plugs and reducers. Reducers provided for reduction to 1 1/2", 1 1/4", 1", 3/4", and 1/2" (38mm, 32mm, 25mm, 19.1mm, and 12.7mm) conduit. Minimum concrete depth is 4" (102mm) and maximum concrete depth is 6" (152mm). Minimum capacity is 50 cu. in. (819ml) and maximum capacity is 100 cu. in. (1639ml). Box dimensions are 4 1/8" W x 8 1/4" L x 6 3/16" (105mm x 210mm x 157mm).

Country of Origin: USA

NOTE: Insert spacer should not be removed until after concrete pour.

NOTE: Box can be connected together to create a two- or three-gang option.

All cover assemblies for the Modulink 880MP Series Floor Box have TopGuard protection.



Modulink 880MP Series Solid Brass Cover Plate Flanges Ordering Information

817B

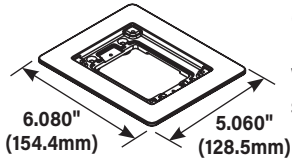

One-Gang Brass Combination Carpet & Tile Flange – Accepts Ortronics® MAB6TJ TracJack and MAB3S2 Series II adapters and Wiremold CM Series inserts, sold separately.

Country of Origin: China

837B

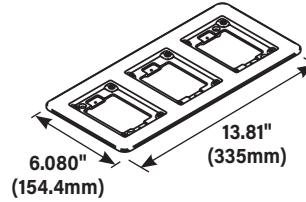

Three-Gang Brass Combination Carpet and Tile Flange – Accepts Ortronics® MAB6TJ TracJack and MAB3S2 Series II adapters and Wiremold CM Series inserts, sold separately.

Country of Origin: China

827B

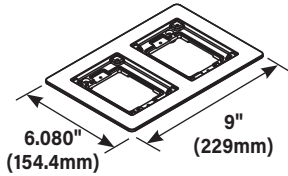

Two-Gang Brass Combination Carpet and Tile Flange – Accepts Ortronics® MAB6TJ TracJack and MAB3S2 Series II adapters and Wiremold CM Series inserts, sold separately.

Country of Origin: China

Modulink 880MP Series Metal Cover Plates Ordering Information

828R

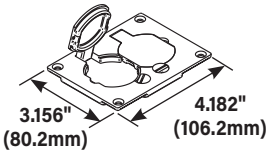

Brass Duplex Cover Plate – Flip lids. Can also be used with a 106 type communication adapter.

Country of Origin: China

828DLR

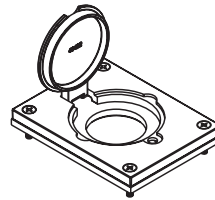

Brass Single Locking Receptacle Cover Plate – Single flip lid cover for 20A or 30A single locking receptacles. Device opening is 2 5/8" (67mm). For use with maximum female locking device of 1.58" diameter, and maximum male plug face of 2.25" diameter.

Country of Origin: China

828GFITC

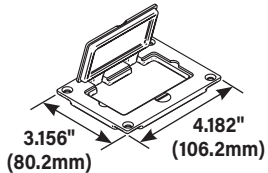

Brass GFI Cover Plate – May be used with Activate and Ortronics® Connectivity Systems in conjunction with 817B, 827B, and 837B Flanges.

Country of Origin: China

828SPTC

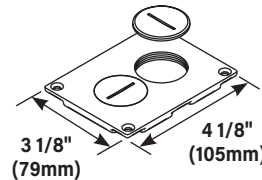

Brass Duplex Cover Plate – Screw plugs. Screw plugs are 1 1/2" (38mm) in diameter.

Country of Origin: China

828DPGFITC

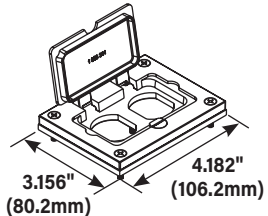

Brass Rectangular Cover Plate – Allows for mounting of a duplex style receptacle with a rectangular style flip lid cover.

Country of Origin: China

829STC

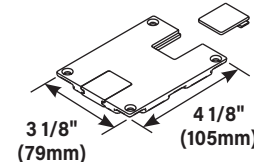

Brass Communication Cover Plate – Data slides. Feed through only, not for use with a mounting plate for communication jacks.

Country of Origin: China

NOTE: Brass covers and flanges are not interchangeable with aluminum or nonmetallic covers and flanges. Nonmetallic covers are interchangeable with aluminum flanges.

All cover assemblies for the Modulink 880MP Series Floor Box have TopGuard protection.



Modulink 880MP Series Metal Cover Plates Ordering Information

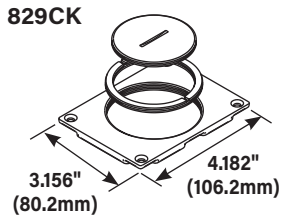

829CK
Brass Communication Cover Plate – 2 5/8" and 2 1/4" (67mm and 57mm) plugs.

Country of Origin: China

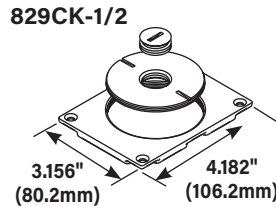

829CK-1/2
Brass Communication Cover Plate – 2 5/8" and 1/2" (67mm and 12.7mm) plugs.

Country of Origin: China

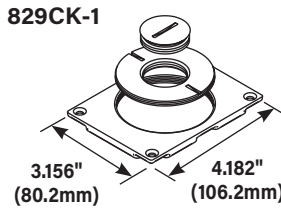

829CK-1
Brass Communication Cover Plate – 2 5/8" and 1" (67mm and 25mm) plugs.

Country of Origin: China

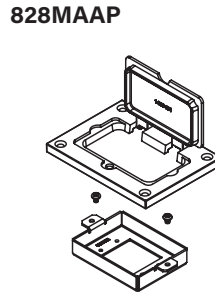

828MAAP
A/V Adapter Plate – Sheet metal adapter plate that accepts two (2) Extron, Electronics MAAP style device plates (sold separately). For use with 828GFITC, 828GFITCAL or 828PRGFI cover plates. (Sold separately.)

Country of Origin: China

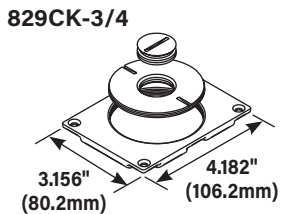

829CK-3/4
Brass Communication Cover Plate – 2 5/8" and 3/4" (67mm and 19.1mm) plugs.

Country of Origin: China

Modulink 880MP Series Brushed Aluminum Cover Plate Flanges Ordering Information

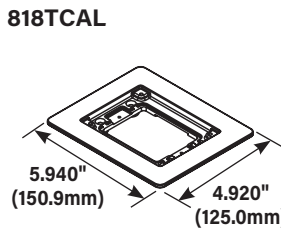

818TCAL
One-Gang Brushed Aluminum Combination Carpet and Tile Flange – Accepts Ortronics® MAB6TJ TracJack and MAB3S2 Series II adapters and Wiremold CM Series inserts, sold separately.

Country of Origin: China

NOTE: Brushed aluminum flanges come with beveled edges.

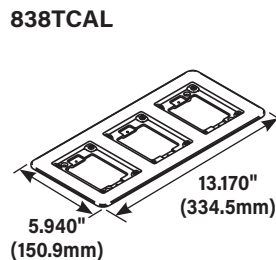

838TCAL
Three-Gang Brushed Aluminum Combination Carpet and Tile Flange – Accepts Ortronics® MAB6TJ TracJack and MAB3S2 Series II adapters and Wiremold CM Series inserts, sold separately.

Country of Origin: China

NOTE: Brushed aluminum flanges come with beveled edges.

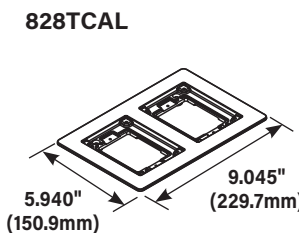

828TCAL
Two-Gang Brushed Aluminum Combination Carpet and Tile Flange – Accepts Ortronics® MAB6TJ TracJack and MAB3S2 Series II adapters and Wiremold CM Series inserts, sold separately.

Country of Origin: China

NOTE: Brushed aluminum flanges come with beveled edges.

NOTE: Brass covers and flanges are not interchangeable with aluminum or nonmetallic covers and flanges. Nonmetallic covers are interchangeable with aluminum flanges.

All cover assemblies for the Modulink 880MP Series Floor Box have TopGuard protection.



Modulink 880MP Series Brushed Aluminum Cover Plate Flanges Ordering Information

828R-TCAL

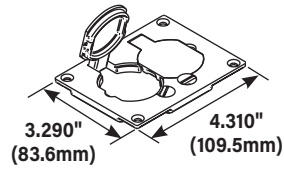

Brushed Aluminum Duplex Cover Plate – Flip lids. Can also be used with a 106 type communication adapter.

Country of Origin: China

830CKTCAL-1

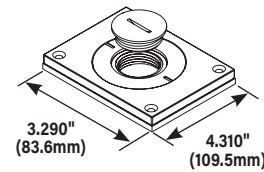

Brushed Aluminum Cover Plate – Power or communication plate with 2" (51mm) and 1" (25mm) plugs.

Country of Origin: China

NOTE: Acceptable for use with threaded conduit when passing through power cables.

828GFITCAL

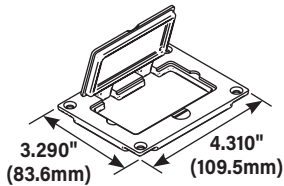

Brushed Aluminum GFI Cover Plate – May be used with Activate and Ortronics® Connectivity Systems in conjunction with 817B, 827B, and 837B Flanges.

Country of Origin: China

830CKTCAL-3/4

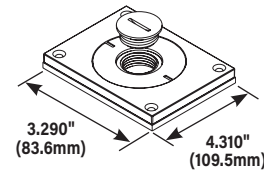

Brushed Aluminum Cover Plate – Power or communication plate with 2" (51mm) and 3/4" (19.1mm) plugs.

Country of Origin: China

NOTE: Acceptable for use with threaded conduit when passing through power cables.

828DPGFITCAL

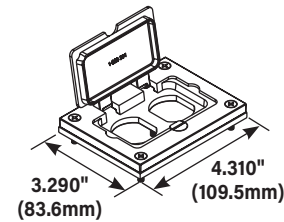

Brushed Aluminum Rectangular Cover Plate – Allows for mounting of a duplex style receptacle with a rectangular style flip lid cover.

Country of Origin: China

830CKTCAL-1/2

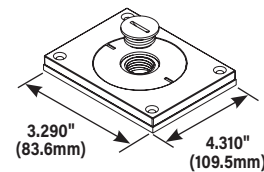

Brushed Aluminum Cover Plate – Power or communication plate with 2" (51mm) and 1/2" (12.7mm) plugs.

Country of Origin: China

NOTE: Acceptable for use with threaded conduit when passing through power cables.

828DLRAL

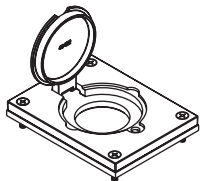

Brushed Aluminum Single Locking Receptacle Cover Plate – Single flip lid cover for 20A or 30A single locking receptacles. Device opening is 2 5/8" (67mm). For use with maximum female locking device of 1.58" diameter, and maximum male plug face of 2.25" diameter.

Country of Origin: China

828MAAP

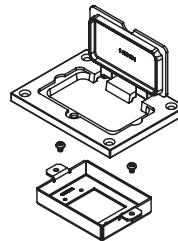

A/V Adapter Plate – Sheet metal adapter plate that accepts two (2) Extron® Electronics MAAP style device plates (sold separately). For use with 828GFITCAL, 828GFITCAL or 828PRGFI cover plates. (Sold separately.)

Country of Origin: China

830CKTCAL

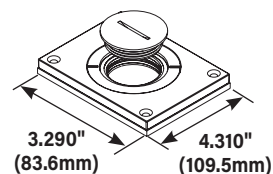

Brushed Aluminum Cover Plate – Power or communication plate with 2" (51mm) and 1 1/4" (32mm) plugs.

Country of Origin: China

NOTE: Acceptable for use with threaded conduit when passing through power cables.

NOTE: Brass covers and flanges are not interchangeable with aluminum or nonmetallic covers and flanges. Nonmetallic covers are interchangeable with aluminum flanges.

All cover assemblies for the Modulink 880MP Series Floor Box have TopGuard protection.



Modulink 880MP Series Powder-Coated Aluminum Cover Plate Flanges Ordering Information

817TCAL-BK*
817TCAL-GY*
817TCAL-BS
817TCAL-NK
817TCAL-BZ

One-Gang Powder-Coated Aluminum Combination Carpet and Tile Flange – Accepts Ortronics® MAB6TJ TracJack and MAB3S2 Series II adapters and Wiremold CM Series inserts, sold separately. Flanges are available in five decorative colors: black, gray, brass, nickel and bronze.

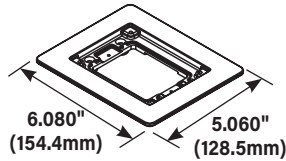

Country of Origin: China

828GFITCAL-BK*
828GFITCAL-GY*
828GFITCAL-BS
828GFITCAL-NK
828GFITCAL-BZ

Powder-Coated Aluminum Rectangular Cover Plate – Allows for mounting a duplex receptacle (Decorator or GFCI style) with a rectangular flip cover.

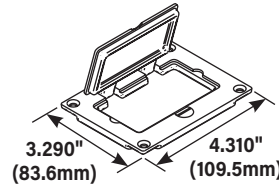

Country of Origin: China

827TCAL-BK*
827TCAL-GY*
827TCAL-BS
827TCAL-NK
827TCAL-BZ

Two-Gang Powder-Coated Aluminum Combination Carpet and Tile Flange – Accepts Ortronics® MAB6TJ TracJack and MAB3S2 Series II adapters and Wiremold CM Series inserts, sold separately. Flanges are available in five decorative colors: black, gray, brass, nickel and bronze.

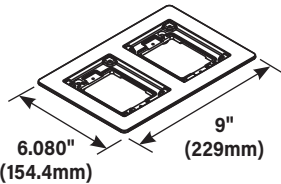

Country of Origin: China

829CKAL-1BK
829CKAL-1GY
829CKAL-1BS
829CKAL-1NK
829CKAL-1BZ

Powder-Coated Aluminum Cover Plate – Power or communication plate with 2" (51mm) and 1" (25mm) plugs. Covers are available in five decorative colors: black, gray, brass, nickel and bronze.

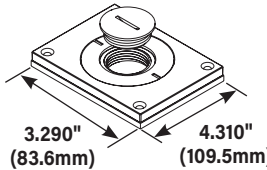

Country of Origin: China

NOTE: Acceptable for use with threaded conduit when passing through power cables.

837TCAL-BK*
837TCAL-GY*
837TCAL-BS
837TCAL-NK
837TCAL-BZ

Three-Gang Powder-Coated Aluminum Combination Carpet and Tile Flange – Accepts Ortronics® MAB6TJ TracJack and MAB3S2 Series II adapters and Wiremold CM Series inserts, sold separately. Flanges are available in five decorative colors: black, gray, brass, nickel and bronze.

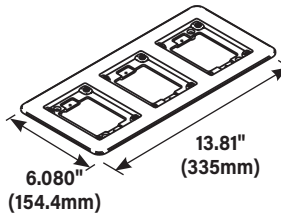

Country of Origin: China

829CKAL-3/4BK
829CKAL-3/4GY
829CKAL-3/4BS
829CKAL-3/4NK
829CKAL-3/4BZ

Powder-Coated Aluminum Cover Plate – Power or communication plate with 2" (51mm) and 3/4" (19.1mm) plugs. Covers are available in five decorative colors: black, gray, brass, nickel and bronze.

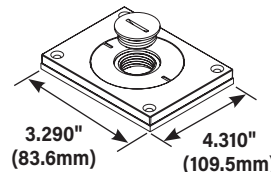

Country of Origin: China

828R-TCAL-BK*
828R-TCAL-GY*
828R-TCAL-BS
828R-TCAL-NK
828R-TCAL-BZ

Powder-Coated Aluminum Duplex Cover Plate – Flip lids. Can also be used with a 106 type communication adapter.

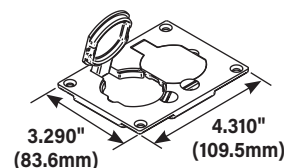

Country of Origin: China

828MAAP

A/V Adapter Plate – Sheet metal adapter plate that accepts two (2) Extron, Electronics MAAP style device plates (sold separately). For use with 828GFITC, 828GFITCAL or 828PRGFI cover plates. (Sold separately.)

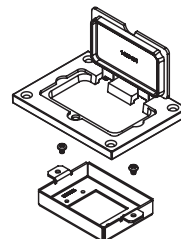

Country of Origin: China

NOTE: Brass covers and flanges are not interchangeable with aluminum or nonmetallic covers and flanges. Nonmetallic covers are interchangeable with aluminum flanges.

*Black and Gray colors are available as BAA compliant product by adding NA suffix.

All cover assemblies for the Modulink 880MP Series Floor Box have TopGuard protection.



Modulink 880MP Series Nonmetallic Cover Plate Flanges Ordering Information

817PCC-BLK
817PCC-BRN

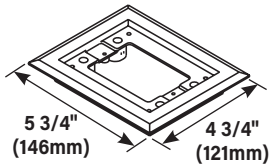

One-Gang Nonmetallic Carpet Flange – Available in black or brown. For Ortronics® connectivity use with 829PFLRT Cover. For Activate connectivity use with 829PFL Cover. Accepts Ortronics® MAB6TJ TracJack and MAB3S2 Series II adapters and Wiremold CM Series inserts, sold separately.

Country of Origin: Mexico

837PCC-BLK
837PCC-BRN

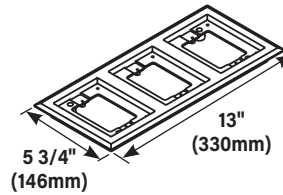

Three-Gang Nonmetallic Carpet Flange – Available in black or brown. For Ortronics® connectivity use with 829PFLRT Cover. For Activate connectivity use with 829PFL Cover. Accepts Ortronics® MAB6TJ TracJack and MAB3S2 Series II adapters and Wiremold CM Series inserts, sold separately.

Country of Origin: Mexico

827PCC-BLK
827PCC-BRN

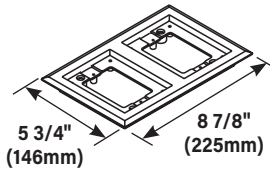

Two-Gang Nonmetallic Carpet Flange – Available in black or brown. For Ortronics® connectivity use with 829PFLRT Cover. For Activate connectivity use with 829PFL Cover. Accepts Ortronics® MAB6TJ TracJack and MAB3S2 Series II adapters and Wiremold CM Series inserts, sold separately.

Country of Origin: Mexico

NOTE: Brass covers and flanges are not interchangeable with aluminum or nonmetallic covers and flanges. Nonmetallic covers are interchangeable with aluminum flanges.

NOTE: UL Listed for tile, terrazzo, and carpet floors.

All cover assemblies for the Modulink 880MP Series Floor Box have TopGuard protection.



Modulink 880MP Series Nonmetallic Cover Plates Ordering Information

828PR-BLK
828PR-BRN

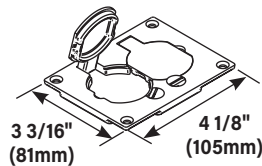

Nonmetallic Duplex Cover Plate – Flip lids. Available in black or brown. Can also be used with a 106 type communication bezel.

Country of Origin: USA

829PFLRT-BLK
829PFLRT-BRN

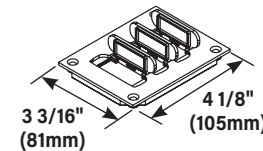

Nonmetallic Communication Cover Plate – Individual flip lids.* Available in black or brown. Gasket and Ortronics® MAB6TJ TracJack and MAB3S2 Series II adapters included.

Country of Origin: USA

828PRGFI-BLK
828PRGFI-BRN

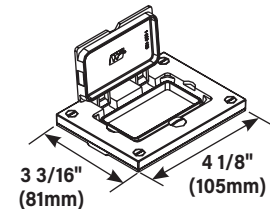

Nonmetallic GFI Cover Plate – Available in black or brown. May be used with Activate and Ortronics® Connectivity systems in conjunction with 817, 827 and 837PCC Series flanges.

Country of Origin: USA

829PCK-BLK
829PCK-BRN

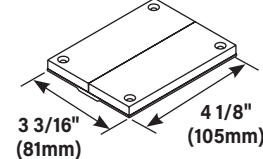

Nonmetallic Communication Cover Plate – Breakouts. Available in black or brown. Feed through only, not for use with a mounting plate for communication jacks.

Country of Origin: USA

828PFL-BLK*
828PFL-BRN*

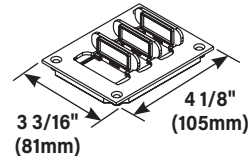

Nonmetallic Communication Cover Plate – Individual flip lids.* Available in black or brown. Gasket and Activate, CM-MAB adapters. Wiremold Open System inserts included.

Country of Origin: USA

829PSTC-BLK
829PSTC-BRN

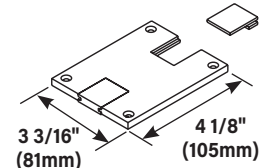

Nonmetallic Communication Cover Plate – Data slides. Available in black or brown. Feed through only, not for use with a mounting plate for communication jacks.

Country of Origin: USA

* Replacement flip lids can be ordered under Cat. No. PFL-BLK and PFL-BRN. Each Cat. No. comes with three flip lids. The above cover plates are listed for tile and carpet applications.

NOTE: Brass covers and flanges are not interchangeable with aluminum or nonmetallic covers and flanges. Nonmetallic covers are interchangeable with aluminum flanges.

Modulink 880MP Series Floor Boxes Mounting Options for Connectivity Inserts

Flush installation with Activate installed using the Activate bezel, or Ortronics® installed using the Ortronics® bezels.

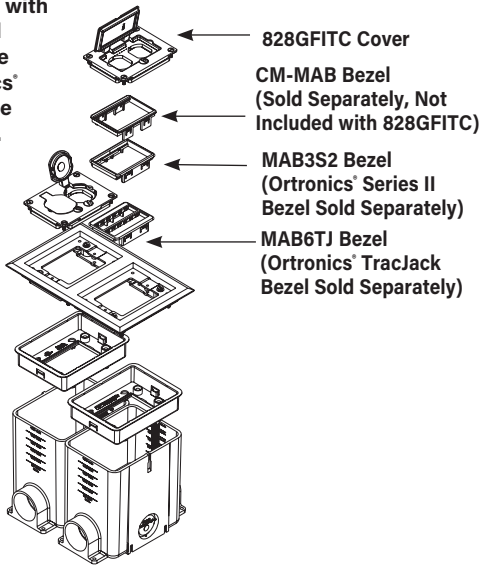

- 828GFITC Cover
- CM-MAB Bezel (Sold Separately, Not Included with 828GFITC)
- MAB3S2 Bezel (Ortronics® Series II Bezel Sold Separately)
- MAB6TJ Bezel (Ortronics® TracJack Bezel Sold Separately)

Recessed installation with Activate installed directly into the 880MPA Adjusting Ring. Ortronics® inserts cannot be inserted directly into 880MPA, see below for Ortronics® solution.

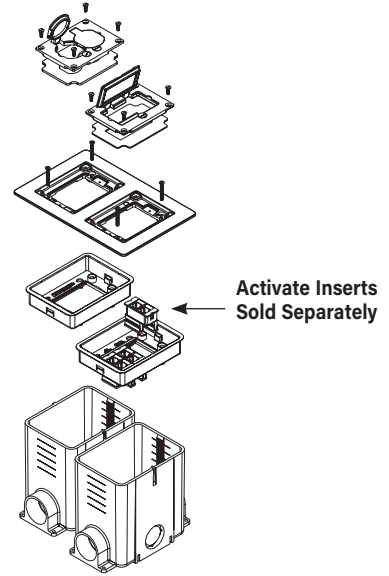

Activate Inserts Sold Separately

Flush installation with Ortronics® installed using 829PFLRT Cover or Activate installed using 829PFL Cover.

NOTE: Part is approved for scrub water applications only with inserts in the flush position.

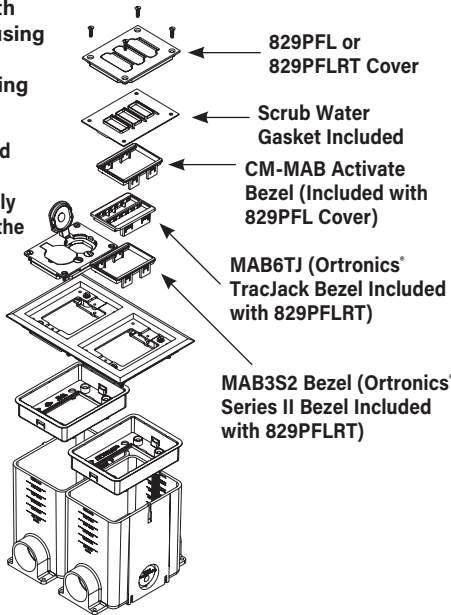

- 829PFL or 829PFLRT Cover
- Scrub Water Gasket Included
- CM-MAB Activate Bezel (Included with 829PFL Cover)
- MAB6TJ (Ortronics® TracJack Bezel Included with 829PFLRT)
- MAB3S2 Bezel (Ortronics® Series II Bezel Included with 829PFLRT)

Fiber Optic Installation (Activate Only).

Fiber Optic Insert (Sold Separately)

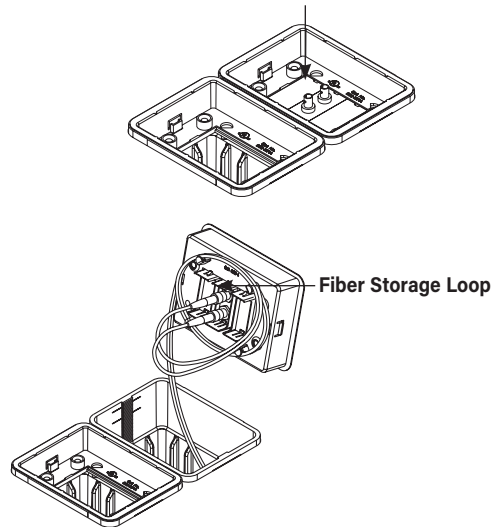

Fiber Storage Loop

NOTE: All brand and product names referenced in this document are registered trademarks or trademarks of their respective holders.