

Code•Master™ 2 Emergency PLT Factory Sealed Luminaires

Explosionproof, Dust-Ignitionproof

52 W, 64 W, 84 W Fluorescent. For Use with Threaded Metal Conduit.

NEC:

Class I, Division 1 and 2, Groups C, D
Class II, Division 1 and 2, Groups E, F, G
Class III
NEMA 4X
Marine Type Electric Fixtures

NEC:

Outside Type (Salt Water)
Suitable for use in Wet Locations
NFPA101, Life Safety Code

Applications

- Ideal for use in chemical and petrochemical plants, such as manufacturers of plastics, paints and thinners; in refineries; and in other process areas where ignitable vapors, dust, moisture and corrosive elements may be present.
- Suitable for use in wet locations.

Features

- Auxiliary (emergency) lighting should be used to provide a lighted means of egress for personnel in walkways, catwalks, stairs, doorways, tunnels, ramps and aisles.
- Auxiliary (emergency) lighting should be used to provide “instant on” illumination during power failures.
- Arrangement of heat-producing components results in more efficient heat dissipation for cooler fixture operation.
- Safe, easy servicing without disconnecting any wiring. Patented “wireless” design means the threading of the fixture unit onto mounting hood makes electrical connection. This allows for the fixture unit to easily thread off mounting hood for convenient servicing or for immediate replacement with a “stand-by” unit. Only wiring required is attaching two wires to connection block in mounting hood.
- Connection block is easily wired: (a) loosen two screws; (b) make wire connections; and (c) reposition connection block.
- Acme double-lead threads speed installation and fixture removal from mounting hood – only half as many turns are required as for single-lead threads. The threads do not stick or gall, eliminating the troublesome problems often encountered with single-lead threads during fixture unit removal.
- All threaded joints are flame-tight.
- Factory sealed. External seals not required.
- Fluorescent light source reduces energy costs.
- Fluorescent lamp life of 10,000 hours reduces relamping costs compared to incandescent.
- Strategic location of lamp sockets in combination with the interior prism design of the glass globe provides optimum light distribution and control.
- Superior corrosion resistance with epoxy powder coat finish.
- Choice of mountings: pendant, ceiling, bracket and stanchion.
- Fiberglass-reinforced polyester reflectors in standard dome, deep dome or 30° angle are ideal in installations where luminaire is subject to exceptionally severe corrosive atmospheres. The high bay aluminum reflector is designed for installations where mounting height work planes range from 6 to 9 m (20 to 30 ft).
- Optional guards protect globes from damage. Guards secure to fixture with three screws.
- Fixture (52, 64 or 84 W) is available for semi-continuous operation (one AC ballast permits two-lamp illumination when power is on and one battery pack permits one-lamp illumination when AC power is interrupted).
- Minimum operating temperature: 0 °C (32 °F).
- Maximum operating temperature: 40 °C (104 °F).

Battery Pack Information

- Long life, high temperature, nickel-cadmium (Ni-Cad) battery.
- Dual voltage (120/277 V, 60 Hz) solid state charger on open circuit board.
- Five-year life expectancy.
- Wiring instructions for “Push-To-Test” button are supplied with fixture.



Illustrated Features

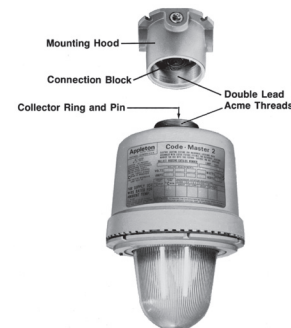

- Remote EEFDB factory sealed “Push-To-Test” station is available to verify emergency operation (order separately).
- Red indicator light is provided with each battery pack to indicate when the battery is charging.

Standard Materials

- Ballast bodies, guards and pendant mounting hoods: copperfree (4/10 of 1% max.) aluminum
- Ceiling, bracket and stanchion mounting hoods: sand-cast copperfree (4/10 of 1% max.) aluminum
- Reflectors: aluminum or fiberglass reinforced polyester

Standard Finishes

- Ballast bodies, guards and mounting hoods: epoxy powder coat finish, electrostatically applied for complete, uniform corrosion protection

Options

- Fuse kit CF2 for field installation.

NEC Certifications and Compliances

- UL Standard: UL 924, UL 844, UL 1598
- UL Listed: E165014

Code•Master™ 2 Emergency PLT Factory Sealed Luminaires

Explosionproof, Dust-Ignitionproof

52 W, 64 W, 84 W Fluorescent. For Use with Threaded Metal Conduit.

NEC:
 Class I, Division 1 and 2, Groups C, D
 Class II, Division 1 and 2, Groups E, F, G
 Class III
 NEMA 4X
 Marine Type Electric Fixtures

NEC:
 Outside Type (Salt Water)
 Suitable for use in Wet Locations
 NFPA101, Life Safety Code

Classified Area Suitability of Code•Master 2 Emergency Series (Suitability includes use of reflector)

Lamp Type	Lamps Watts	Ambient Temp °C (°F)	Class I, Division 1 and 2 With Globe or with Globe and Reflector UL/NEC Temp. Ident. No.		Class II, Division 1 and 2 With Globe or with Globe and Reflector UL/NEC Temp. Ident. No.	
			Nameplate Marking	Groups	Nameplate Marking	Groups
PLT	52	40 (104)	T6	C, D	T4	E, F, G
	64	40 (104)	T6	C, D	T4	E, F, G
	84	40 (104)	T6	C, D	T4	E, F, G

“T” Numbers Represent the Maximum Surface Temperature for Class I, Division 1 Locations and Maximum Surface Temperature Under Dust Blanket for Class II, Division 1 Locations.

“T” Number	T1	350	325	T2	T2A	T2B	T2C	T2D	T3	T3A	T3B	T3C	T4	T4A	T5	T6
Temp. Range (°C)	351-450	326-350	301-325	281-300	261-280	231-260	216-230	201-215	181-200	166-180	161-165	136-160	121-135	101-120	86-100	85
Temp. Range (°F)	664-842	619-662	574-617	538-572	502-536	448-500	421-446	394-419	358-392	331-356	322-329	277-320	250-275	214-248	187-212	185

Fixture and Accessory Weights in kg (lb)

Fixture Size	Fixture Weight	Reflector Weight	Guard Weight
52 W	20.4 (44.97)	1.4 (3.09)	0.9 (1.98)
64 W	20.4 (44.97)	1.4 (3.09)	0.9 (1.98)
84 W	20.4 (44.97)	1.4 (3.09)	0.9 (1.98)

Mounting Hood Weights kg (lb)

Pendant	Ceiling	Bracket	Stanchion
0.9 (1.98)	1.8 (3.97)	2.7 (5.95)	0.9 (1.98)

Electrical Specification for AC Operation

Fixture Wattage	Line Voltage (V)	Frequency (Hz)	Type of Ballast	Line Amps (A)	Maximum Wattage (W/W)	Catalog Number ①
52	120	60	PLT Electronic	0.49	52	CMBFS5212
52	277	60	PLT Electronic	0.20	52	CMBFS5227
64	120	60	PLT Electronic	0.57	64	CMBFS6412
64	277	60	PLT Electronic	0.24	64	CMBFS6427
84	120	60	PLT Electronic	0.73	84	CMBFS8412
84	277	60	PLT Electronic	0.31	84	CMBFS8427

① For optional fusing, order kit -CF2.

Code•Master™ 2 Emergency PLT Factory Sealed Luminaires

Explosionproof, Dust-Ignitionproof





52 W, 64 W, 84 W Fluorescent. For Use with Threaded Metal Conduit.

NEC:

Class I, Division 1 and 2, Groups C, D
 Class II, Division 1 and 2, Groups E, F, G
 Class III
 NEMA 4X
 Marine Type Electric Fixtures

NEC:

Outside Type (Salt Water)
 Suitable for use in Wet Locations
 NFPA101, Life Safety Code

	Lamp Watts	Lamp Type	Hub Size (Inches)	Catalog Number ②③
Pendant 	52	PLT	3/4	CFPS5275
			1	CFPS5210
	64	PLT	3/4	CFPS6475
			1	CFPS6410
	84	PLT	3/4	CFPS8475
			1	CFPS8410
Ceiling 	52	PLT	3/4	CFCS5275
			1	CFCS5210
	64	PLT	3/4	CFCS6475
			1	CFCS6410
	84	PLT	3/4	CFCS8475
			1	CFCS8410
Bracket 	52	PLT	3/4	CFBS5275
			1	CFBS5210
	64	PLT	3/4	CFBS6475
			1	CFBS6410
	84	PLT	3/4	CFBS8475
			1	CFBS8410
25° Stanchion 	52	PLT	1-1/4 or 1-1/2 ①	CFSS52150
			1-1/4 or 1-1/2 ①	CFSS64150
	64	PLT	1-1/4 or 1-1/2 ①	CFSS64150
			1-1/4 or 1-1/2 ①	CFSS84150
	84	PLT	1-1/4 or 1-1/2 ①	CFSS84150
			1-1/4 or 1-1/2 ①	CFSS84150

Fixture Units

Ballast body with globe. Indicate voltage desired by adding voltage suffix to Fixture Unit catalog number listed below.

	Lamp Watts	Lamp Type	Unit Catalog Number	Add Voltage Suffixes	
				120 V	277 V
	52	PLT	CMBFS52	12	27
	64	PLT	CMBFS64	12	27
	84	PLT	CMBFS84	12	27

① 1-1/2" tapped hub furnished with 1-1/2" to 1-1/4" reducer.
 ② To order fixture with guard, add suffix -G before adding voltage suffix.
 ③ Add voltage suffix -12L for 120 V with lamp; or -27L for 277 V with lamp.

Code•Master™ 2 Emergency PLT Factory Sealed Luminaires





Explosionproof, Dust-Ignitionproof

52 W, 64 W, 84 W Fluorescent. For Use with Threaded Metal Conduit.

NEC:
 Class I, Division 1 and 2, Groups C, D
 Class II, Division 1 and 2, Groups E, F, G
 Class III
 NEMA 4X
 Marine Type Electric Fixtures

NEC:
 Outside Type (Salt Water)
 Suitable for use in Wet Locations
 NFPA101, Life Safety Code

Mounting Hoods

		Hub Size Inches	Catalog Number
Pendant		One Hub	
Ceiling		Four hubs, Three Close-Up Plugs	CAC-75
			CAC-100
Bracket		Four hubs, Three Close-Up Plugs	CALB-75
			CALB-100
25° Stanchion		One Hub	1-1/4 or 1-1/2 ①
Mounting Adapter with Connection Block		Permits use of existing A-51 mounting hoods (AAC Ceiling or AALB Bracket) with the new Code•Master 2 Fixture Unit. After removing existing Fixture Unit and adapter, screw in the new CMAD-1 Adapter. Then thread the new Fixture Unit into the CMAD-1.	CMAD-1

① 1-1/2" tapped hub furnished with 1-1/2" to 1-1/4" reducer.

Code•Master™ 2 Emergency PLT Factory Sealed Luminaires

Explosionproof, Dust-Ignitionproof







52 W, 64 W, 84 W Fluorescent. For Use with Threaded Metal Conduit.

NEC:

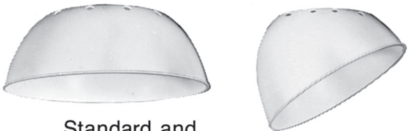
Class I, Division 1 and 2, Groups C, D
 Class II, Division 1 and 2, Groups E, F, G
 Class III
 NEMA 4X
 Marine Type Electric Fixtures

NEC:

Outside Type (Salt Water)
 Suitable for use in Wet Locations
 NFPA101, Life Safety Code

	Description	Catalog Number
Polyester Reflectors		
 <p>Standard and Deep Dome</p>	Standard Dome	CMR-4ST
	Deep Dome ①	CMR-4DD
	30° Angle	CMR-4AN
Aluminum High Bay Reflectors		
		CMR-4HB
Prismatic Glass Globes		
	52, 64, 84 W PLT	CGL-400
Aluminum Guards		
	52, 64, 84 W PLT	CGU4
Connection Block – For Code•Master 2 PLT Fixtures		
	52 W - 84 W	PLT32RS
	52 W - 84 W	VPT-7

① Fixtures when used with Deep Dome Refletors are NOT UL Listed.

Code•Master™ 2 Emergency PLT Factory Sealed Luminaires

Explosionproof, Dust-Ignitionproof

52 W, 64 W, 84 W Fluorescent. For Use with Threaded Metal Conduit.

NEC:
 Class I, Division 1 and 2, Groups C, D
 Class II, Division 1 and 2, Groups E, F, G
 Class III
 NEMA 4X
 Marine Type Electric Fixtures

NEC:
 Outside Type (Salt Water)
 Suitable for use in Wet Locations
 NFPA101, Life Safety Code

Dimensions in Millimeters (Inches)

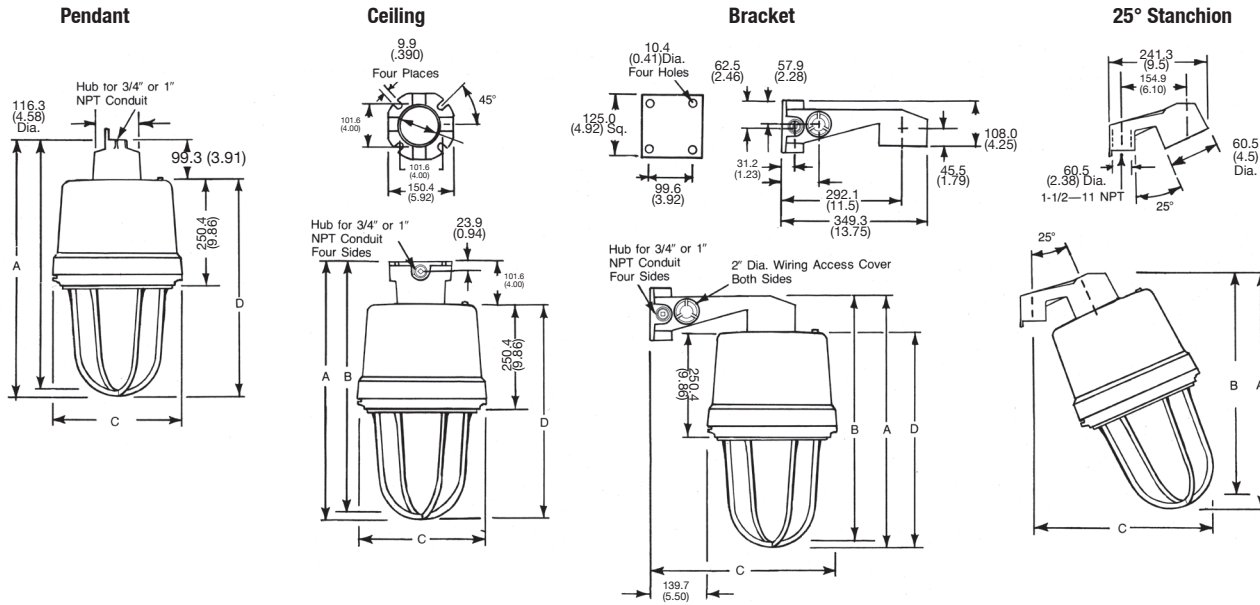

	Pendant				Ceiling				Bracket			25° Stanchion			
	A	B	C	D	A	B	C	D	A	B	C	D	A	B	C
52-84 W	622.3 (24.50)	596.9 (23.50)	304.8 (12.00)	517.1 (20.36)	618.7 (24.36)	593.3 (23.36)	304.8 (12.00)	517.1 (20.36)	625.1 (24.61)	599.7 (23.61)	444.5 (17.50)	517.1 (20.36)	563.9 (22.20)	538.5 (21.20)	444.5 (17.50)

Reflector Dimensions in Millimeters (Inches)

Type Reflector	A	B	C	Standard and Deep Dome ①	30° Angle	High Bay
Standard Dome	284.5 (11.20)	149.9 (5.90)	475.0 (18.70)			
Deep Dome ①	268.2 (10.56)	177.8/ (7.00)	515.6 (20.30)			

① Fixtures when used with Deep Dome Reflectors are NOT UL Listed.

Code•Master™ 2 Emergency PLT Factory Sealed Luminaires

Explosionproof, Dust-Ignitionproof

* Photometric data is based on a fixture with two 32 W Compact Fluorescent PL-T lamps (2,400 lumens each). For candlepower values of fixtures with two 26 W PL-T lamps (1,800 lumens each), multiply by 0.75. For Candlepower values of fixtures with two 42 W PL-T Lamps, (3,200 lumens each) multiply by 1.34.

NEC:

Class I, Division 1 and 2, Groups C, D
 Class II, Division 1 and 2, Groups E, F, G
 Class III
 NEMA 4X
 Marine Type Electric Fixtures

NEC:

Outside Type (Salt Water)
 Suitable for use in Wet Locations
 NFPA101, Life Safety Code

Photometric Data

Total Luminaire Efficiency = 79.8%

CIE Type – Semi-Direct

Plane	Spacing Criteria
0-180	2.88
90-270	2.88
Diagonal	2.82

Zone	Lumens
0-10	17.70
10-20	61.05
20-30	132.44
30-40	236.78
40-50	336.66
50-60	421.68
60-70	485.34
70-80	517.29
80-90	513.72
90-100	468.70
100-110	352.77
110-120	200.85
120-130	73.54
130-140	11.28
140-150	1.12
150-160	0.31
160-170	0.06
170-180	0.00

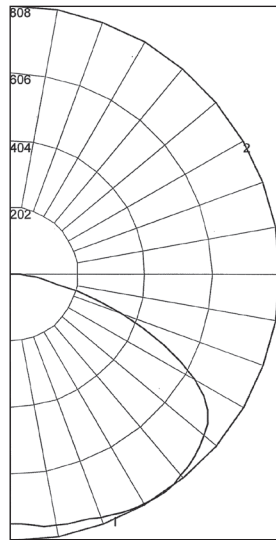

Maximum Candela = 493
 Located at Horizontal Angle = 0, Vertical Angle = 70
 #1 – Vertical Plane through Horizontal Angles (0-180)
 (Through Max. Cd.)
 #2 – Horizontal Cone through Vertical Angle (70)
 (Through Max. Cd.)

REPORT NUMBER: **CMBF64G**

64 W (two 32 W lamps) Fluorescent Fixture with Globe only *

Coefficients of Utilization – Zonal Cavity Method

Effective Floor Cavity Reflectance 0.20

% Ceiling Rcc	% Walls Rw	80		70		50		30		10		0							
		70	50	30	10	70	50	30	10	50	30	10	0						
0	0	90	90	90	90	85	85	85	85	76	76	76	68	68	68	60	60	60	57
1	1	76	70	65	60	71	66	61	57	58	54	51	51	48	45	45	42	40	36
2	2	67	58	51	45	63	55	48	42	48	43	38	42	37	34	36	32	29	26
3	3	60	49	41	35	56	46	39	33	40	34	29	35	30	26	30	26	23	20
4	4	54	43	34	28	50	40	32	26	35	28	23	30	25	21	26	21	18	15
5	5	49	37	29	23	46	35	27	22	31	24	19	26	21	17	23	18	15	12
6	6	45	33	25	19	42	31	23	18	27	21	16	23	18	14	20	16	12	10
7	7	41	29	22	16	38	28	20	15	24	18	14	21	16	12	18	14	10	8
8	8	38	26	19	14	36	25	18	13	22	16	12	19	14	10	16	12	9	7
9	9	35	24	17	12	33	23	16	11	20	14	10	17	12	9	15	11	8	9
10	10	33	22	15	11	31	21	14	10	18	13	9	16	11	8	14	10	7	5

Zonal Lumen Summary

Zone	Lumens	% Lamp	% Fixture	Zone	Lumens	% Lamp	% Fixture
0-30	211.19	4.4	5.5	90-120	1022.32	21.3	26.7
0-40	447.97	9.3	11.7	90-130	1095.85	22.8	28.6
0-60	1206.31	25.1	31.5	90-150	1108.26	23.1	28.6
0-90	2722.64	56.7	71.1	90-180	1108.63	23.1	28.9
				0-180	3831.28	79.8	100.0

Total Luminaire Efficiency = 66.5%

CIE Type – Direct

Plane	Spacing Criteria
0-180	1.62
90-270	1.62
Diagonal	1.74

Zone	Lumens
0-10	73.25
10-20	220.57
20-30	368.60
30-40	505.61
40-50	603.19
50-60	638.42
60-70	497.24
70-80	226.17
80-90	57.98
90-100	1.64
100-110	0.00
110-120	0.00
120-130	0.00
130-140	0.00
140-150	0.00
150-160	0.00
160-170	0.00
170-180	0.00

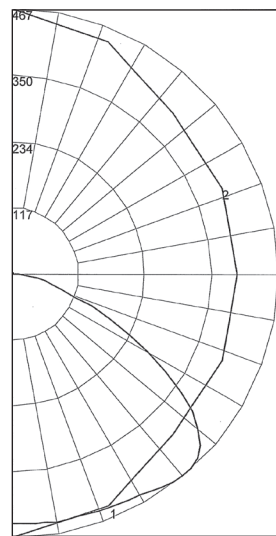

Maximum Candela = 808
 Located at Horizontal Angle = 0, Vertical Angle = 35
 #1 – Vertical Plane through Horizontal Angles (0-180)
 (Through Max. Cd.)
 #2 – Horizontal Cone through Vertical Angle (35)
 (Through Max. Cd.)

REPORT NUMBER: **CMBF64ST**

64 W (two 32 W lamps) Fluorescent Fixture with Globe and Standard Dome Reflector *

Coefficients of Utilization – Zonal Cavity Method

Effective Floor Cavity Reflectance 0.20

% Ceiling Rcc	% Walls Rw	80		70		50		30		10		0							
		70	50	30	10	70	50	30	10	50	30	10	0						
0	0	79	79	79	79	77	77	77	77	74	74	74	71	71	71	68	68	68	66
1	1	72	69	66	63	70	67	64	62	64	62	60	62	60	58	59	58	56	55
2	2	65	59	54	50	63	58	53	49	55	52	48	53	50	47	51	48	46	45
3	3	59	51	45	41	57	50	45	40	48	43	40	46	42	39	44	41	38	37
4	4	53	45	38	34	52	44	38	33	42	37	33	40	36	32	39	35	32	30
5	5	49	39	33	28	47	39	33	28	37	32	28	36	31	28	35	31	27	26
6	6	45	35	29	24	43	34	29	24	33	28	24	32	27	24	31	27	23	22
7	7	41	32	25	21	40	31	25	21	30	25	21	29	24	21	28	24	20	19
8	8	38	29	23	19	37	28	22	18	27	22	18	26	22	18	26	21	18	17
9	9	35	26	20	16	34	26	20	16	25	20	16	24	19	16	23	19	16	15
10	10	33	24	18	15	32	24	18	15	23	18	15	22	18	15	22	17	14	13

Zonal Lumen Summary

Zone	Lumens	% Lamp	% Fixture	Zone	Lumens	% Lamp	% Fixture
0-30	662.42	13.8	20.7	90-120	1.64	0.0	0.1
0-40	1168.03	24.3	36.6	90-130	1.64	0.0	0.1
0-60	2409.64	50.2	75.5	90-150	1.64	0.0	0.1
0-90	3191.04	66.5	99.9	90-180	1.64	0.0	0.1
				0-180	3192.68	66.5	100.0

Code•Master™ 2 Emergency PLT Factory Sealed Luminaires

Explosionproof, Dust-Ignitionproof

* Photometric data is based on a fixture with two 32 W Compact Fluorescent PL-T lamps (2,400 lumens each). For candlepower values of fixtures with two 26 W PL-T lamps (1,800 lumens each), multiply by 0.75. For Candlepower values of fixtures with two 42 W PL-T Lamps. (3,200 lumens each) multiply by 1.34.

NEC:
 Class I, Division 1 and 2, Groups C, D
 Class II, Division 1 and 2, Groups E, F, G
 Class III
 NEMA 4X
 Marine Type Electric Fixtures

NEC:
 Outside Type (Salt Water)
 Suitable for use in Wet Locations
 NFPA101, Life Safety Code

Photometric Data

Total Luminaire Efficiency = 57.4%

CIE Type – Direct

Plane	Spacing Criteria
0-180	1.52
90-270	1.70
Diagonal	1.62

Zone	Lumens
------	--------

0-10	62.13
10-20	187.93
20-30	317.49
30-40	428.14
40-50	471.22
50-60	454.23
60-70	384.77
70-80	276.31
80-90	157.68
90-100	13.45
100-110	0.00
110-120	0.00
120-130	0.00
130-140	0.00
140-150	0.00
150-160	0.00
160-170	0.00
170-180	0.00

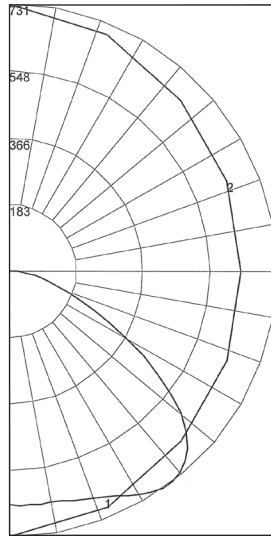

Maximum Candela = 731
 Located at Horizontal Angle = 90, Vertical Angle = 37.5
 #1 – Vertical Plane through Horizontal Angles (90–270)
 (Through Max. Cd.)
 #2 – Horizontal Cone through Vertical Angle (37.5)
 (Through Max. Cd.)

REPORT NUMBER: **CMBF64AN**

64 W (two 32 W lamps) Fluorescent Fixture with Globe and 30° Angle Dome Reflector *

Coefficients of Utilization – Zonal Cavity Method

Effective Floor Cavity Reflectance 0.20

% Ceiling % Walls	Rcc Rw	80		70		50		30		10		0						
		70	50	30	10	70	50	30	10	50	30	10	50	30	10	0		
0	68	68	68	68	67	67	67	67	64	64	64	61	61	61	58	58	58	57
1	61	58	55	52	59	56	54	51	54	51	49	51	49	48	49	48	46	45
2	55	49	45	41	53	48	44	40	46	43	39	44	41	39	42	40	38	36
3	50	43	37	33	48	42	37	33	40	36	32	38	35	32	37	34	31	30
4	45	37	32	28	44	37	31	27	35	31	27	34	30	27	32	29	26	25
5	41	33	28	23	40	32	27	23	31	27	23	30	26	23	29	25	22	21
6	38	30	24	20	37	29	24	20	28	23	20	27	23	20	26	22	19	18
7	35	27	21	18	34	26	21	18	25	21	17	24	20	17	24	20	17	16
8	32	24	19	16	32	24	19	15	23	19	15	22	18	15	22	18	15	14
9	30	22	17	14	29	22	17	14	21	17	14	20	16	14	20	16	13	12
10	28	20	16	12	28	20	15	12	19	15	12	19	15	12	18	15	12	11

Zonal Lumen Summary

Zone	Lumens	% Lamp	% Fixture	Zone	Lumens	% Lamp	% Fixture
0-30	567.55	11.8	20.6	90-120	13.45	0.3	0.5
0-40	995.69	20.7	36.2	90-130	13.45	0.3	0.5
0-60	1921.14	40.0	69.8	90-150	13.45	0.3	0.5
0-90	2739.90	57.1	99.5	90-180	13.45	0.3	0.5
				0-180	2753.35	57.4	100.0

Total Luminaire Efficiency = 67.2%

CIE Type – Direct

Plane	Spacing Criteria
0-180	1.44
90-270	1.44
Diagonal	1.60

Zone	Lumens
------	--------

0-10	88.95
10-20	260.61
20-30	413.34
30-40	539.82
40-50	630.36
50-60	641.74
60-70	436.60
70-80	164.84
80-90	47.37
90-100	1.92
100-110	0.00
110-120	0.00
120-130	0.00
130-140	0.00
140-150	0.00
150-160	0.00
160-170	0.00
170-180	0.00

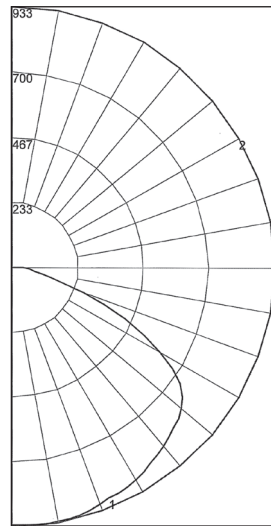

Maximum Candela = 933
 Located at Horizontal Angle = 0, Vertical Angle = 7.5
 #1 – Vertical Plane through Horizontal Angles (0–180)
 (Through Max. Cd.)
 #2 – Horizontal Cone through Vertical Angle (7.5)
 (Through Max. Cd.)

REPORT NUMBER: **CMBF64DD**

64 W (two 32 W lamps) Fluorescent Fixture with Globe and Deep Dome Reflector *

Coefficients of Utilization – Zonal Cavity Method

Effective Floor Cavity Reflectance 0.20

% Ceiling % Walls	Rcc Rw	80		70		50		30		10		0						
		70	50	30	10	70	50	30	10	50	30	10	50	30	10	0		
0	80	80	80	80	78	78	78	78	75	75	75	71	71	71	69	69	69	67
1	73	70	67	65	71	68	66	63	66	63	61	63	61	60	60	59	58	56
2	66	61	56	52	65	59	55	52	57	53	50	55	52	49	53	50	48	47
3	60	53	47	43	59	52	47	43	50	45	42	48	44	41	46	43	40	39
4	55	47	41	36	53	46	40	36	44	39	35	42	38	35	41	37	34	33
5	50	41	35	31	49	41	35	30	39	34	30	38	33	30	37	33	29	28
6	46	37	31	26	45	36	30	26	35	30	26	34	29	26	33	29	25	24
7	43	33	27	23	41	33	27	23	32	27	23	31	26	23	30	26	22	21
8	40	30	24	20	38	30	24	20	29	24	20	28	23	20	27	23	20	19
9	37	28	22	18	36	27	22	18	26	21	18	26	21	18	25	21	18	16
10	34	25	20	16	34	25	20	16	24	19	16	24	19	16	23	19	16	15

Zonal Lumen Summary

Zone	Lumens	% Lamp	% Fixture	Zone	Lumens	% Lamp	% Fixture
0-30	762.91	15.9	23.7	90-120	1.92	0.0	0.1
0-40	1302.73	27.1	40.4	90-130	1.92	0.0	0.1
0-60	2574.82	53.6	79.8	90-150	1.92	0.0	0.1
0-90	3223.63	67.2	99.9	90-180	1.92	0.0	0.1
				0-180	3225.55	57.4	100.0

Code•Master™ 2 Emergency PLT Factory Sealed Luminaires

Explosionproof, Dust-Ignitionproof

* Photometric data is based on a fixture with two 32 W Compact Fluorescent PL-T lamps (2,400 lumens each). For candlepower values of fixtures with two 26 W PL-T lamps (1,800 lumens each), multiply by 0.75. For Candlepower values of fixtures with two 42 W PL-T Lamps, (3,200 lumens each) multiply by 1.34.

NEC:
 Class I, Division 1 and 2, Groups C, D
 Class II, Division 1 and 2, Groups E, F, G
 Class III
 NEMA 4X
 Marine Type Electric Fixtures

NEC:
 Outside Type (Salt Water)
 Suitable for use in Wet Locations
 NFPA101, Life Safety Code

Photometric Data

Total Luminaire Efficiency = 58.9%

CIE Type – Direct

Plane	Spacing Criteria
0-180	0.82
90-270	0.82
Diagonal	0.92

Zone	Lumens
0-10	239.15
10-20	599.67
20-30	645.20
30-40	625.54
40-50	452.95
50-60	185.71
60-70	58.40
70-80	15.26
80-90	4.25
90-100	0.69
100-110	0.00
110-120	0.00
120-130	0.00
130-140	0.00
140-150	0.00
150-160	0.00
160-170	0.00
170-180	0.00

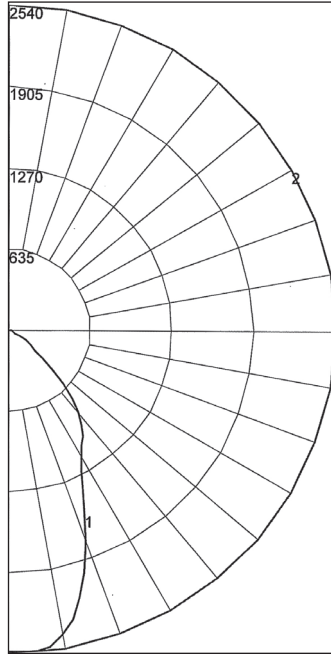

Maximum Candela = 2540
 Located at Horizontal Angle = 0, Vertical Angle = 5
 #1 – Vertical Plane through Horizontal Angles (0–180)
 (Through Max. Cd.)
 #2 – Horizontal Cone through Vertical Angle (5)
 (Through Max. Cd.)

REPORT NUMBER: **CMBF64HB**

64 W (two 32 W lamps) Fluorescent Fixture with Globe and High Bay Reflector *

Coefficients of Utilization – Zonal Cavity Method

Effective Floor Cavity Reflectance 0.20

% Ceiling Rcc	80	70				50				30				10				0
		70	50	30	10	70	50	30	10	50	30	10	50	30	10	50	30	
0	70	70	70	70	68	68	68	68	65	65	65	63	63	63	60	60	60	59
1	66	64	63	61	65	63	62	60	61	59	58	58	57	57	56	56	55	54
2	62	59	56	54	61	58	55	53	56	54	52	54	52	51	52	51	50	49
3	58	54	51	48	57	53	50	47	51	49	47	50	48	46	49	47	45	44
4	55	50	46	43	54	49	45	43	48	44	42	46	44	42	45	43	41	40
5	51	46	42	39	50	45	41	39	44	41	38	43	40	38	42	39	37	36
6	48	42	38	35	47	42	38	35	41	37	35	40	37	35	39	36	34	33
7	46	39	35	32	45	39	35	32	38	35	32	37	34	32	37	34	32	31
8	43	37	33	30	42	36	32	30	36	32	30	35	32	29	34	31	29	28
9	41	34	30	28	40	34	30	28	33	30	27	33	30	27	32	29	27	26
10	38	32	28	26	38	32	28	26	31	28	26	31	28	25	30	27	25	25

Zonal Lumen Summary

Zone	Lumens	% Lamp	% Fixture	Zone	Lumens	% Lamp	% Fixture
0-30	1484.03	30.9	52.5	90-120	0.69	0.0	0.0
0-40	2109.57	43.9	74.6	90-130	0.69	0.0	0.0
0-60	2748.23	57.3	97.2	90-150	0.69	0.0	0.0
0-90	2826.12	58.9	100.0	90-180	0.69	0.0	0.0
				0-180	2628.80	58.9	100.0

APPLETON™

FLUORESCENT/AREA: NEC/CEC EXPLOSIONPROOF