



Main

Range of Product	Harmony 9001K
Product or Component Type	Joystick controller
Device short name	9001K
Sale per indivisible quantity	1
Type of operator	To centre spring return
Operator profile	80 mm long operating shaft

Complementary

Bezel material	Chromium plated metal
Mounting diameter	1.18 in (30 mm)
Net Weight	0.82 lb(US) (0.372 kg)
Operating position	Horizontal
Shape of signaling unit head	Octagonal
Operator position information	3 positions
Contacts type and composition	2 NO
Contact operation	Slow-break
Contacts usage	Standard
Positive opening	Without
Connections - terminals	Screw clamp terminals, 1 x 0.22...2 x 1.5 mm ² IEC 60947-1
Tightening torque	7.08 lbf.in (0.8 N.m) IEC 60947-1
Shape of screw head	Cross slotted
Contacts material	Silver alloy contacts
Short-circuit protection	10 A cartridge fuse IEC 60947-5-1
[I _{th}] conventional free air thermal current	10 A
[U _i] rated insulation voltage	250 V 3) IEC 60947-1
[U _{imp}] rated impulse withstand voltage	2.5 kV IEC 60947-1
[I _e] rated operational current	3 A 240 V, AC-15, A600-Q600 NEMA 0.55 A 125 V, DC-13, A600-Q600 NEMA
[I _{cm}] rated short-circuit making capacity	12 KA 600 V AC-15, 7200 VA 15 KA 480 V AC-15, 7200 VA 30 KA 240 V AC-15, 7200 VA 60 kA 120 V AC-15, 7200 VA
Rated breaking capacity	3 KA 240 V AC-15, 720 VA 6 KA 120 V AC-15, 720 VA 1.2 KA 600 V AC-15, 720 VA 1.5 KA 480 V AC-15, 720 VA 0.1 KA 600 V DC-13 0.27 KA 250 V DC-13 0.55 kA 125 V DC-13
Device presentation	Complete product

Environment

Protective treatment	TC
Ambient Air Temperature for Storage	-40...158 °F (-40...70 °C)
Ambient Air Temperature for Operation	-13...158 °F (-25...70 °C)
Overvoltage category	II IEC 61140
IP degree of protection	IP66 IEC 60529
NEMA degree of protection	NEMA 1 NEMA 12 NEMA 13 NEMA 2 NEMA 3 NEMA 3R NEMA 4
Standards	EN/IEC 60947-5-4 JIS C8201-5-1 UL 508 JIS C 852 EN/IEC 60947-1 CSA C22.2 No 14 EN/IEC 60947-5-1 JIS C8201-1
Product Certifications	UL 508 NEMA
Vibration resistance	7 gn 2...500 Hz)IEC 60068-2-6
Shock resistance	50 gn IEC 60068-2-27



Ordering and shipping details

Category	21426-9001 K (NOT KA,KM,KX)
Discount Schedule	CS1
GTIN	3389110915327
Nbr. of units in pkg.	1
Package weight(Lbs)	10.23 oz (290.0 g)
Returnability	Yes
Country of origin	MX

Packing Units

Unit Type of Package 1	PCE
Package 1 Height	2.28 in (5.8 cm)
Package 1 width	2.13 in (5.4 cm)
Package 1 Length	6.50 in (16.5 cm)
Unit Type of Package 2	S03
Number of Units in Package 2	24
Package 2 Weight	17.18 lb(US) (7.793 kg)
Package 2 Height	11.81 in (30 cm)
Package 2 width	11.81 in (30 cm)
Package 2 Length	15.75 in (40 cm)

Offer Sustainability

Sustainable offer status	Green Premium product
California proposition 65	WARNING: This product can expose you to chemicals including: Lead and lead compounds, which is known to the State of California to cause cancer and birth defects or other reproductive harm. For more information go to www.P65Warnings.ca.gov
REACH Regulation	 REACH Declaration
EU RoHS Directive	Pro-active compliance (Product out of EU RoHS legal scope)  EU RoHS Declaration
Mercury free	Yes
RoHS exemption information	 Yes

China RoHS Regulation	China RoHS Declaration
Environmental Disclosure	Product Environmental Profile
WEEE	The product must be disposed on European Union markets following specific waste collection and never end up in rubbish bins.

Contractual warranty

Warranty	18 months
----------	-----------

Dimensions

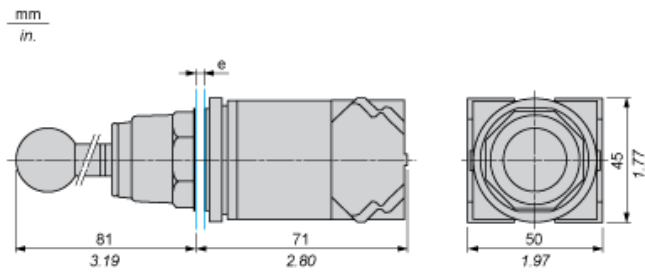

e panel thickness: 1 to 6 mm / 0.04 to 0.24 in.

Contact Block Mounting Position

Top and Rear views

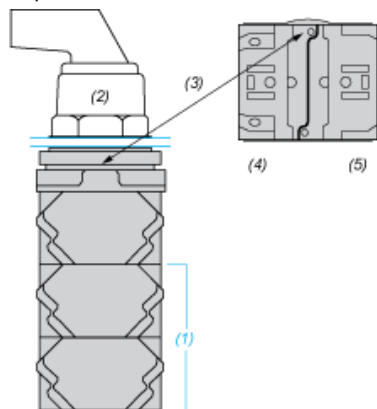

- (1) It is possible to mount up to 3 levels of contacts blocks (maximum of 6 contacts blocks)
- (2) Operator
- (3) Locating notch
- (4) Side 1
- (5) Side 2

Panel Cut-Out

Clearance

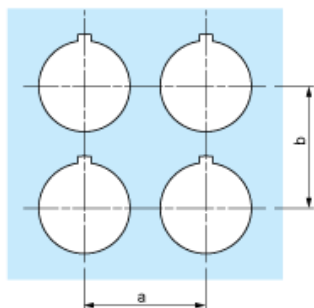

Legend plate	a min.		b min.	
	mm	in.	mm	in.
9001KN2••	57.2	2.25	44.5	1.75
9001KN3••	57.2	2.25	50.8	2.00

Individual Cut-outs Details

2 alternatives

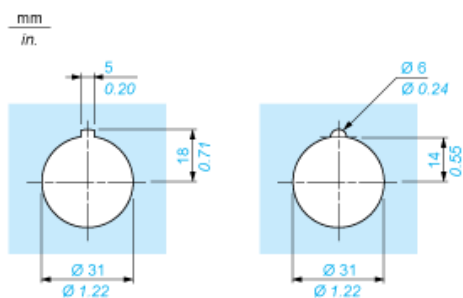

Joystick Positions

