

Mounted Zone Cabling Enclosures and Brackets

Wall Mounted Rack

Wall Mounted Swing Frame

HUBBELL

Features

- Supports up to 70 lb of equipment in limited space applications
- Rear wall mounting aligns with 16" on center studs
- Quick release latches allow for left or right hinging

Ordering Information

Rack Units	Depth	Catalog Number	UPC Number
12	18"	HPWWMR24	662620809472

Listings

EIA/ECA-310-E Universal Mounting Pattern

Specifications

Material	Cold rolled steel
Frame Gauge	12
Brace Gauge	12
Finish	Black powder coat
Mount	#12-24 Threaded

Characteristics

Access	Swing Frame
Load Capacity	70 lb
Rack Units	12

Accessories

Black Velcro Roll	HVFBK575
9" Velco Strips, Yellow	MCCMV9YL10
#12-24 Screws	1224RRSCRW20

Online Resources

Customer Drawing
Customer Use Drawing
eCatalog

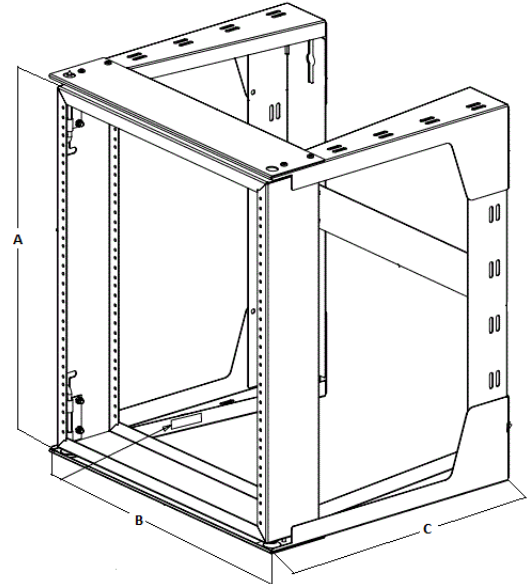

Dimensions- inches (mm)

A	21.1" (536)
B	19.5" (495)
C	18" (457)