

DROP CEILING / ENTRANCE END FITTING FOR USE WITH SURFACE RACEWAY ROUTING SYSTEM

Part Number(s): DCEFX, CFX3, CF3, CFX5, CF5,
ECFX3, ECF3, ECFX5, ECF5

© Panduit Corp. 2022

INSTALLATION INSTRUCTIONS

RW96

Low voltage or power applications up to 600 V

Printed in U.S.A.

1/2", 3/4", & 1" breakouts

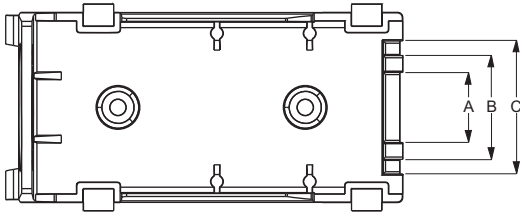
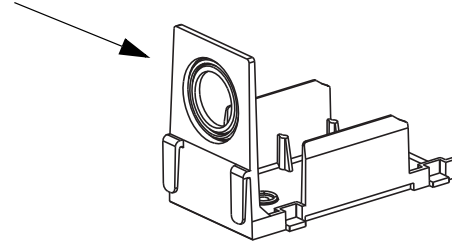
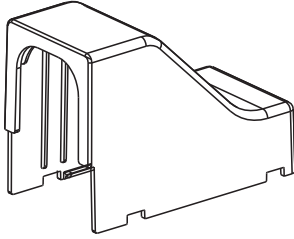

Base Breakouts	Surface Raceway	Coupler	End Cap
A	LD3, LDPH3	N/A	N/A
B	LD5, LDPH5	CFX3**-X, CF3**-E, CFX5**-X, CF5**-E	ECFX3**-X, ECF3**-E, ECFX5**-X, ECF5**-E
C	LD10, LDPH10	N/A	N/A

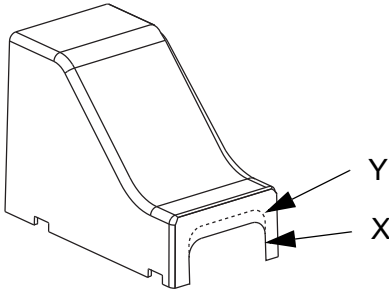

Cover Breakouts	Surface Raceway	Coupler	End Cap
X	LD3, LDPH3 LD5, LDPH5	CFX3**-X, CF3**-E CFX5**-X, CF5**-E	ECFX3**-X, ECF3**-E ECFX5**-X, ECF5**-E
Y	LD10, LDPH10	N/A	N/A

The mounting hardware used to secure the fitting shall be appropriate for the mounting surface.

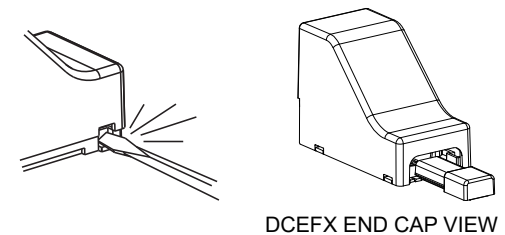
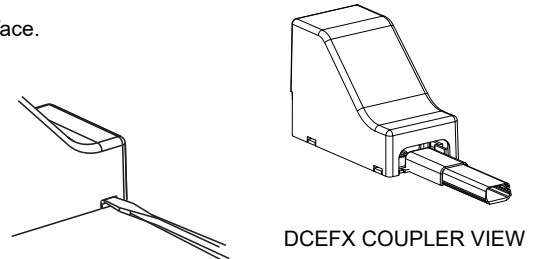
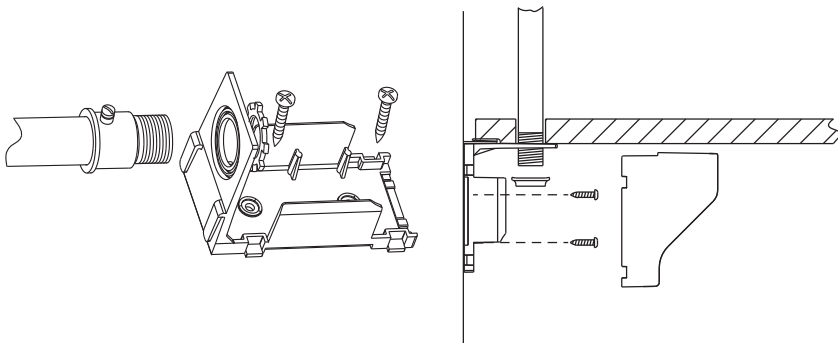

For Instructions in Local Languages
and Technical Support:
www.panduit.com

PANDUIT
www.panduit.com

E-mail:
techsupport@panduit.com
Fax:
866-405-6654