

# Product data sheet

Specifications



battery control module, phaseo  
ABL7 ABL8, 24 to 28.8V DC,  
phaseo ABL7 ABL8, 24V, 20A, for  
regulated SMPS

ABL8BBU24200

! Discontinued - Service only

! Discontinued on: Aug 13, 2024

! End-of-service on: Dec 31, 2025

**Product availability: Non-Stock - Not normally stocked in distribution facility**

## Main

Range of Product	Phaseo
Product or Component Type	Battery control module
Input voltage	24...28.8 V DC
Output voltage	(U <sub>battery</sub> -0.5) V battery mode DC (U <sub>in</sub> -0.25) V nominal mode DC
Maximum output current	20 A

## Complementary

Input voltage limits	22...30 V
Maximum power dissipation in W	7 W
Activation threshold	Adjustable 22...36 V
Number of output channels	1
Current consumption	0.6 A on load 0.1 mA no load ≤ 40.6 A
Output protection type	Against overload, protection technology: 1.5 x In Against short-circuits, protection technology: battery-backed mode, automatic reset Against short-circuits, protection technology: power-supplied mode
Connections - terminals	For diagnostic relay: removable screw terminal block, connection capacity: 1 x 0.75 mm <sup>2</sup> For input connection: screw type terminals, connection capacity: 2 x 0.5...2 x 10 mm <sup>2</sup> AWG 20...AWG 8 For output connection: screw type terminals, connection capacity: 2 x 0.5...2 x 10 mm <sup>2</sup> AWG 20...AWG 8
Fixing mode	By clips 35 mm symmetrical DIN rail horizontal By clips 35 mm symmetrical DIN rail vertical
Operating altitude	6561.68 ft (2000 m)
Marking	CE
Name of test	Electrostatic discharges IEC 61000-4-2 Emission IEC 61000-6-3 Induced electromagnetic field IEC 61000-4-6 level 3 Radiated electromagnetic field IEC 61000-4-3 level 3 Rapid transient IEC 61000-4-4 level 3 Surge IEC 61000-4-5 level 2 Conducted/radiated emissions EN 55022 Class B, 20 %

Price is "List Price" and may be subject to a trade discount – check with your local distributor or retailer for actual price.

<b>Local signalling</b>	1 C/O relay for alarm status 1 C/O relay for battery status 1 C/O relay for power supply status LCD screen for module status
<b>Width</b>	2.4 in (60 mm)
<b>Height</b>	4.9 in (125 mm)
<b>Depth</b>	6.3 in (160 mm)
<b>Product Weight</b>	1.1 lb(US) (0.5 kg)

## Environment

<b>Product Certifications</b>	RCM EAC
<b>Standards</b>	UL 508 CSA C22.2 No 60950-1
<b>Ambient Air Temperature for Operation</b>	-13...140 °F (-25...60 °C)
<b>Ambient Air Temperature for Storage</b>	-40...185 °F (-40...85 °C)
<b>Environmental characteristic</b>	EMC conforming to IEC 61000-6-3 EMC conforming to IEC 61000-6-2 Safety conforming to IEC 60950-1 Safety conforming to EN/IEC 61204-3
<b>IP degree of protection</b>	IP20 conforming to IEC 60529
<b>Dielectric strength</b>	500 V between input and ground 500 V between output and ground
<b>Overvoltage category</b>	Class II conforming to VDE 0106-1
<b>Relative Humidity</b>	0...90 % during operation 0...95 % during storage
<b>MTBF reliability</b>	718708 H at 24 V DC with UTE C80-810 calculation method
<b>Vibration resistance</b>	2 gn (f= 11.9...150 Hz) conforming to IEC 61131-2 3.5 mm (f= 3...11.9 Hz) conforming to IEC 61131-2

## Ordering and shipping details

<b>Category</b>	US1CP1222525
<b>Discount Schedule</b>	CP12
<b>GTIN</b>	3389119406826
<b>Returnability</b>	Yes

## Packing Units

<b>Unit Type of Package 1</b>	PCE
<b>Nbr. of units in pkg.</b>	1
<b>Package 1 Height</b>	3.543 in (9.000 cm)
<b>Package 1 Width</b>	7.677 in (19.500 cm)
<b>Package 1 Length</b>	7.677 in (19.500 cm)
<b>Package weight(Lbs)</b>	3.236 lb(US) (1.468 kg)
<b>Unit Type of Package 2</b>	P06
<b>Number of Units in Package 2</b>	72
<b>Package 2 Height</b>	29.528 in (75.000 cm)
<b>Package 2 Width</b>	23.622 in (60.000 cm)

---

<b>Package 2 Length</b>	31.496 in (80.000 cm)
<b>Package 2 Weight</b>	261.680 lb(US) (118.696 kg)

---

## **Contractual warranty**

---

<b>Warranty (in months)</b>	18
-----------------------------	----



## Environmental Data

Schneider Electric aims to achieve Net Zero status by 2050 through supply chain partnerships, lower impact materials, and circularity via our ongoing “Use Better, Use Longer, Use Again” campaign to extend product lifetimes and recyclability.

[Environmental Data explained >](#)

[How we assess product sustainability >](#)



### Environmental footprint

[Environmental Disclosure](#)

[Product Environmental Profile](#)

## Use Better



### Materials and Substances

Packaging made with recycled cardboard

No

Packaging without single use plastic

No

EU RoHS Directive

[Compliant By Exemption](#)

REACH Regulation

[Reference contains Substances of Very High Concern above the threshold](#)

California proposition 65

**WARNING:** This product can expose you to chemicals including: Lead and lead compounds, which is known to the State of California to cause cancer and birth defects or other reproductive harm. For more information go to [www.P65Warnings.ca.gov](http://www.P65Warnings.ca.gov)

PVC free

Yes

## Use Longer



### Lifetime extension

Repair

No

## Use Again



### Repack and remanufacture

Circularity Profile

[End of Life Information](#)

Take-back

No

WEEE Label



The product must be disposed on European Union markets following specific waste collection and never end up in rubbish bins.

Dimensions Drawings

24 Vdc/20 A Battery Control Module

---

Dimensions

mm  
inch

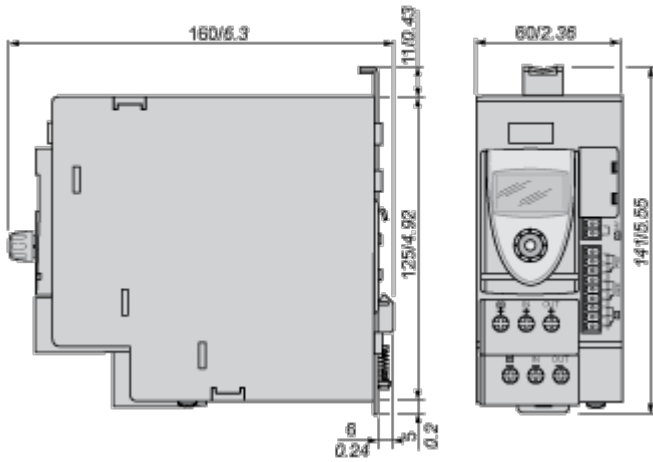

Mounting and Clearance

24 Vdc Battery Control Module

---

Mounting

mm  
inch

AM1 DE200  
IEC/EN 60715

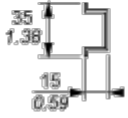

AM1 ED200

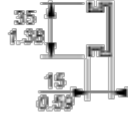

AM1 DP200

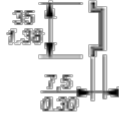

DZ5 MB200



24 Vdc Battery Control Module

---

Clearance

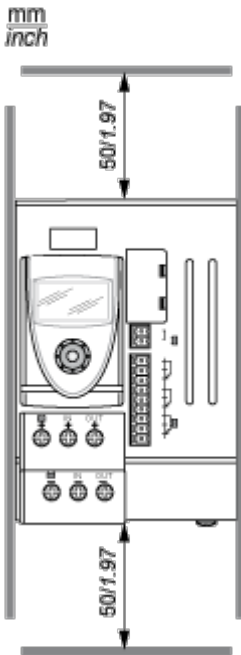

Connections and Schema

24 Vdc Battery Control Module

Wiring Diagram

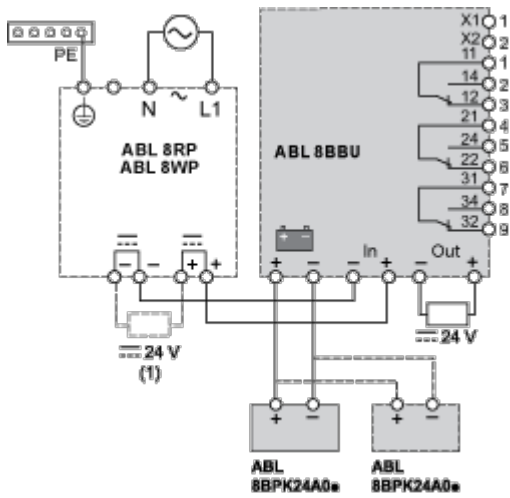







(1) See table below for the maximum unstored charge capacity (µF)

ABL	Max. Unstored Charge Capacity (µF)
8RPS24030	30 000
8RPS24050	50 000
8RPS24100	100 000
8RPM24200	100 000
8WPS24200	100 000
8WPS24400	100 000

24 Vdc Battery Control Module

Outputs States (U = 24 Vdc: I > 5 mA, U = 230 Vac: I < 500 mA)

	<p>No power from the power supply</p>		<p>Power from the power supply</p>
	<p>Alarm or device not supplied</p>		<p>No alarm</p>
	<p>No power from the battery pack</p>		<p>Power from the battery pack</p>



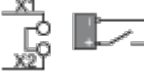





Inputs States (Dry Contact)

	<p>Operational battery</p>		<p>Battery inhibited</p>
---	----------------------------	---	--------------------------

Wiring Requirements

Cable Types and Wire Sizes

IEC / EN

		ABL 8RPS24030 8RPS24050 8RPS24100	ABL 8RPM24200 8WPS24200 8WPS24400
	$\varnothing \le 4 \text{ mm}^2$		
	$\varnothing > 4 \text{ mm}^2$		
<b>ABL 8BBU24200</b> 	In + / -	1...4 mm <sup>2</sup>	4... 10 mm <sup>2</sup>
	 + / -	6 mm <sup>2</sup>	-
	Out + / -	6 mm <sup>2</sup>	-
<b>ABL 8BBU24400</b> 	In + / -	1...4 mm <sup>2</sup>	4... 10 mm <sup>2</sup>
	 + / -	10 mm <sup>2</sup>	-
	Out + / -	10 mm <sup>2</sup>	-
		10 mm <sup>2</sup>	
		-	
	OFF / PSU / Alarm /	0,14... 1 mm <sup>2</sup>	

UL









		ABL 8RPS24030 8RPS24050 8RPS24100	ABL 8RPM24200 8WPS24200 8WPS24400
	$\varnothing \le 12 \text{ AWG}$		
	$\varnothing > 12 \text{ AWG}$		
<b>ABL 8BBU24200</b> 	In + / -	16... 12 AWG	12... 6 AWG
	 + / -	10 AWG	-
	Out + / -	10 AWG	-
<b>ABL 8BBU24400</b> 	In + / -	16... 12 AWG	12... 6 AWG
	 + / -	6 AWG	-
	Out + / -	6 AWG	-
		6 AWG	
		-	
	OFF / PSU / Alarm /	26... 16 AWG	

Image of product / Alternate images

Alternative

---

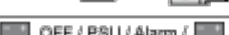