

# Product data sheet

Specifications



## counter module, Modicon M340, high speed, 2 channels

BMXEHC0200

**Product availability: Stock - Normally stocked in distribution facility**

### Main

Range of Product	Modicon M340 automation platform
Product or Component Type	Counter module
Number of channels	2
Maximum counting frequency	60000 Hz
Number of inputs	6
Input compatibility	19.2...30 V 2-wire/3-wire proximity sensor incremental encoder with push-pull outputs, 10...30 V totem pole
Input voltage	24 V DC type 3
Number of outputs	2
Output voltage	24 V DC

### Complementary

Counter functions	Loop (modulo) counting Width modulation Down counting Measure time periods Ratio count Count events 32-bit counter counting Frequency meter
Cycle time	1 ms
Isolation voltage	1500 V 60 s
Input type	3 auxiliary input 3 high speed
Input voltage limits	30 V
Input current	2 mA at 11 V
Voltage state 1 guaranteed	11...30 V
Current state 1 guaranteed	$\geq 6$ mA
Voltage state 0 guaranteed	$< 5$ V
Current state 0 guaranteed	$\leq 1.5$ mA
Discrete output logic	Positive or negative configurable
Maximum output current	2 A per module 0.5 A per output
Output voltage limits	19.2...30 V
Maximum load current	1 A per module 0.5 A per output
Maximum leakage current	0.1 mA at state 0

Price is "List Price" and may be subject to a trade discount – check with your local distributor or retailer for actual price.

Maximum voltage drop	<3 V at state 1
Output overload protection	Integrated
Output short-circuit protection	1.5 A integrated
Overlap time	0.2 ms
Electrical connection	1 connector 10 pins for wiring auxiliary input and sensor power supply 1 connector 16 pins for wiring the sensors of counter 0 1 connector 16 pins for wiring the sensors of counter 1
Current consumption	200 mA 3.3 V DC bus 40 mA 24 V DC rack 80 mA 24 V DC sensor
Module format	Standard
Product Weight	0.247 lb(US) (0.112 kg)

## Environment

Ambient Air Temperature for Operation	32...140 °F (0...60 °C)
Relative Humidity	10...95 % without condensation
IP Degree of Protection	IP20
Directives	2014/35/EU - low voltage directive 2014/30/EU - electromagnetic compatibility
Protective treatment	Standard version

## Ordering and shipping details

Category	US1PC3418160
Discount Schedule	PC34
GTIN	3595863910148
Returnability	Yes
Country of origin	US

## Packing Units

Unit Type of Package 1	PCE
Nbr. of units in pkg.	1
Package 1 Height	2.165 in (5.500 cm)
Package 1 Width	4.528 in (11.500 cm)
Package 1 Length	4.646 in (11.800 cm)
Package weight(Lbs)	4.938 oz (140.000 g)
Unit Type of Package 2	S02
Number of Units in Package 2	15
Package 2 Height	5.906 in (15.000 cm)
Package 2 Width	11.811 in (30.000 cm)
Package 2 Length	15.748 in (40.000 cm)
Package 2 Weight	5.337 lb(US) (2.421 kg)

## Contractual warranty

Warranty (in months)	18
----------------------	----



## Environmental Data

Schneider Electric aims to achieve Net Zero status by 2050 through supply chain partnerships, lower impact materials, and circularity via our ongoing “Use Better, Use Longer, Use Again” campaign to extend product lifetimes and recyclability.

[Environmental Data explained >](#)

[How we assess product sustainability >](#)



### Environmental footprint

Total lifecycle Carbon footprint	101 kg CO2 eq.
Carbon footprint of the manufacturing phase [A1 to A3]	18 kg CO2 eq.
Carbon footprint of the distribution phase [A4]	0 kg CO2 eq.
Carbon footprint of the installation phase [A5]	0 kg CO2 eq.
Carbon footprint of the use phase [B2, B3, B4, B6]	83 kg CO2 eq.
Carbon footprint of the end-of-life phase [C1 to C4]	0.2 kg CO2 eq.
Environmental Disclosure	<a href="#">Product Environmental Profile</a>

## Use Better



### Materials and Substances

Packaging made with recycled cardboard	Yes
Packaging without single use plastic	Yes
EU RoHS Directive	<a href="#">Compliant By Exemption</a>
REACH Regulation	<a href="#">Reference contains Substances of Very High Concern above the threshold</a>
California proposition 65	<b>WARNING:</b> This product can expose you to chemicals including: Lead and lead compounds, which is known to the State of California to cause cancer and birth defects or other reproductive harm. For more information go to <a href="http://www.P65Warnings.ca.gov">www.P65Warnings.ca.gov</a>

## Use Longer



### Lifetime extension

Repair	No
--------	----

## Use Again



### Repack and remanufacture

Recyclability potential, in %	3
Circularity Profile	<a href="#">End of Life Information</a>
Take-back	No

Dimensions Drawings

Modules Mounted on Racks

---

Dimensions

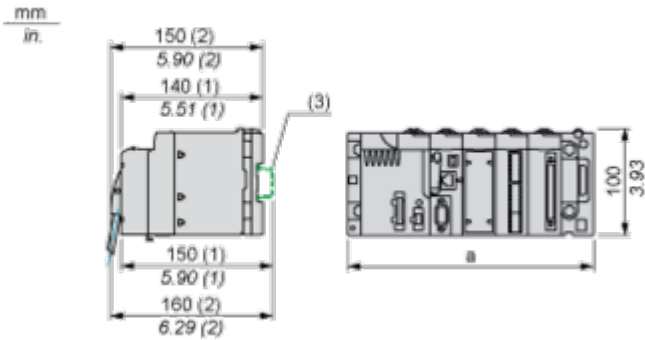

(1) With removable terminal block (cage, screw or spring).

(2) With FCN connector.

(3) On AM1 ED rail: 35 mm wide, 15 mm deep. Only possible with BMXXBP0400/0400H/0600/0600H/0800/0800H rack.

Rack references	a in mm	a in in.
BMXXBP0400 and BMXXBP0400H	242.4	09.54
BMXXBP0600 and BMXXBP0600H	307.6	12.11
BMXXBP0800 and BMXXBP0800H	372.8	14.68
BMXXBP1200 and BMXXBP1200H	503.2	19.81

Connections and Schema

Counting Module Wiring

---

**Note**

The two 16-pin connectors and the 10-pin connector are sold separately and are available in the BMXXTSHSC20 connection kit.

**Assignment of the 16-Pin Connector**

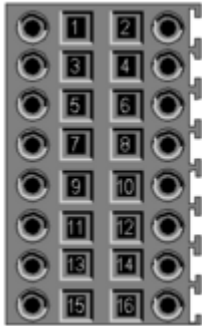

Pin number	Symbol	Description
1, 2, 7, 8	24V_SEN	24 VDC output for sensors supply
5, 6, 13, 14	GND_SEN	24 VDC output for sensors supply
15, 16	FE	Functional earth
3	IN_A	Input A
4	IN_SYNC	Synchronization input
9	IN_B	Input B
10	IN_EN	Enable input selected
11	IN_REF	Homing input
12	IN_CAP	Capture input

**Sensors Connection Example**

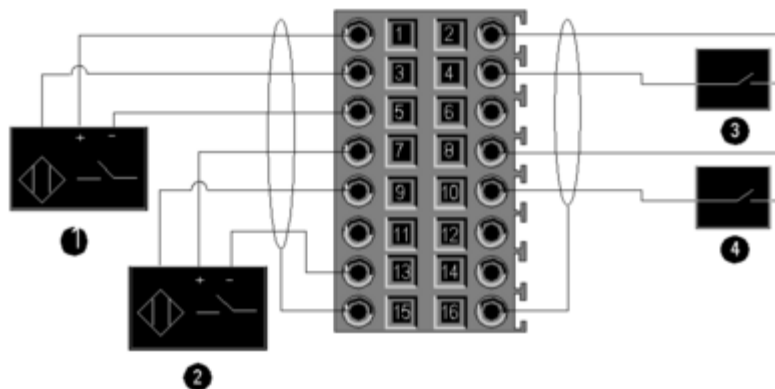

- 1 IN\_A input
- 2 IN\_B input
- 3 IN\_SYNC input (synchronization input)
- 4 IN\_EN input (enable input)

**Encoder Connection Example for Axis Control**

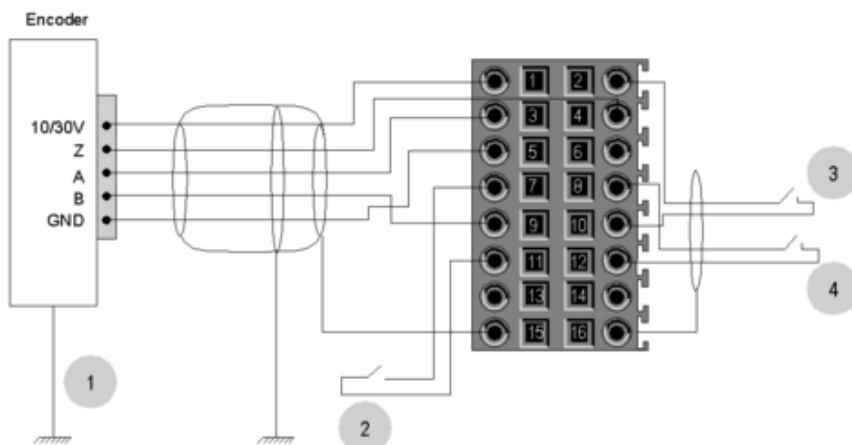

- 1 Encoder (inputs A, B and Z)
- 2 IN\_REF input (homing input)
- 3 IN\_EN input (enable input)
- 4 IN\_CAP input (capture input)

**Assignment of the 10-Pin Connector**

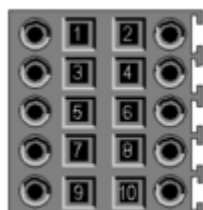

Pin number	Symbol	Description
1	24V_IN	24 VDC input for sensors supply
2	GND_IN	Return 24 VDC input for sensors supply

Pin number	Symbol	Description
5	Q0-1	Q1 output for counting channel 0
6	Q0-0	Q0 output for counting channel 0
7	Q1-1	Q1 output for counting channel 1
8	Q1-0	Q0 output for counting channel 1
9	24V_OUT	24 VDC input for actuators supply
10	GND_OUT	Return 24 VDC input for actuators supply

**Connecting Outputs and Supplies**

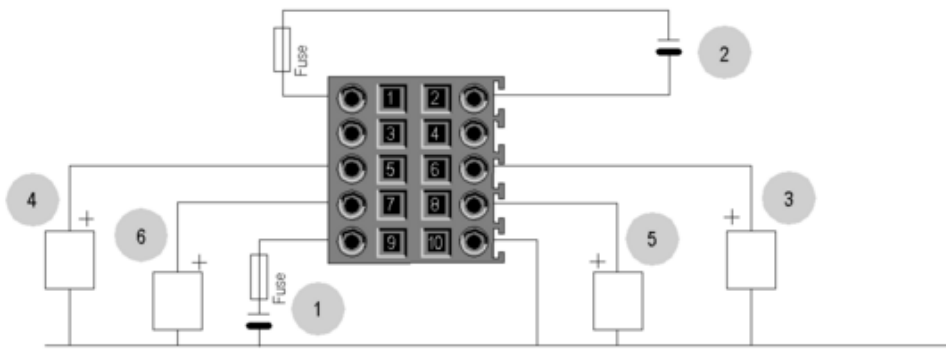

- 1 24 VDC supply for sensors
  - 2 Return 24 VDC supply for sensors
  - 3 Actuator for the Q0 output of counting channel 0
  - 4 Actuator for the Q1 output of counting channel 0
  - 5 Actuator for the Q0 output of counting channel 1
  - 6 Actuator for the Q1 output of counting channel 1
- The Q0 and Q1 outputs are limited by a maximum current of 0.5 A.

**Recommended Circuit for high-Noise Environment Using BMXXSP•••• Electromagnetic Protection Kit**

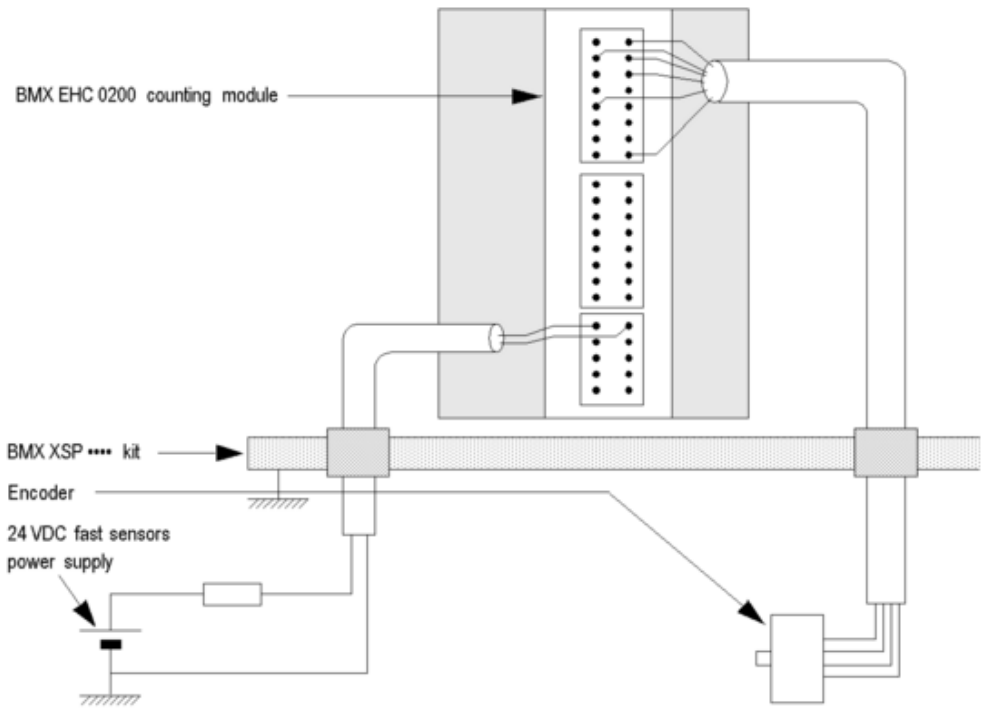

Image of product / Alternate images

Alternative

---

