

Data Sheet | Item Number: 750-538

2-channel relay output; Potential-free; 2 changeover contacts; Intrinsically safe

<https://www.wago.com/750-538>

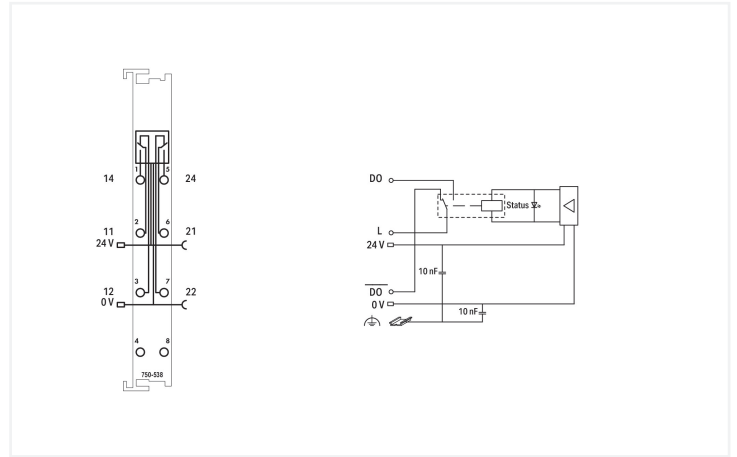
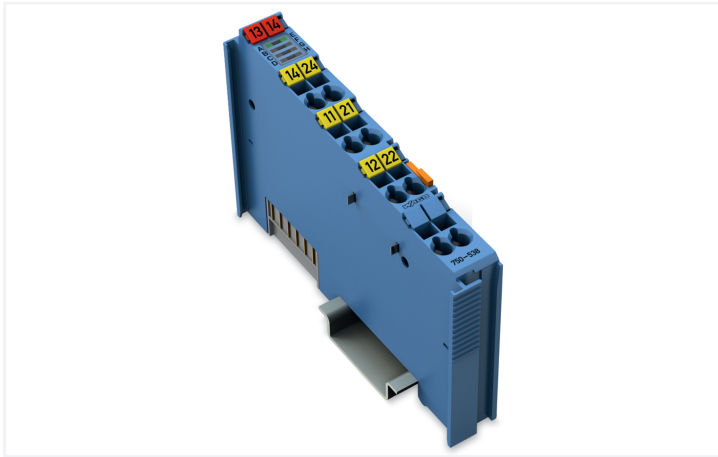

Color: ■ blue

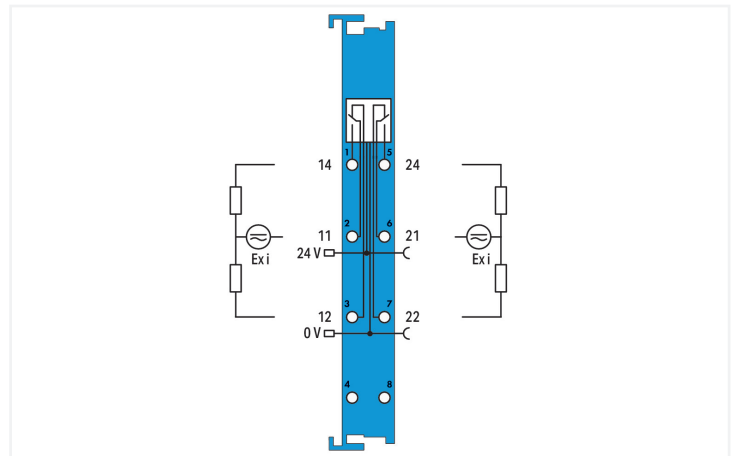
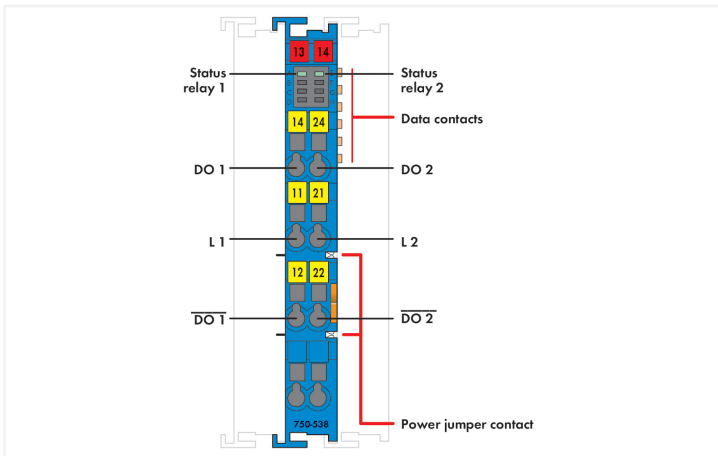

This digital output module switches intrinsically safe circuits of Zone 0+1 (e.g., magnetic valves, contactors and optical/acoustic encoders).

The internal system voltage is used to trigger the relay.

Both maximum switching current and voltage must comply with EN 60079-11.

The state of the relays is indicated by a green LED.

The NO contacts are electrically isolated.

The WAGO I/O System 750/753 must be installed either in Zone 2 or in a non-hazardous area.

Notes

Note

The digital output module must only be operated via 24 VDC Ex i!
General information on explosion protection, including installation regulations, can be found in the WAGO I/O System 750/753 manuals!

Technical data

Item description	2-Channel Relay Output; Changeover contact; Potential-free
Number of digital outputs	2
Total number of channels (module)	2
Signal type	Digital
Signal type (voltage)	100 VAC; 30 VDC
Actuator connection	2 x (3-wire)
Output characteristic	potential-free
Output circuit design	2 changeover contacts Relay
Switching frequency (max.)	0.3 Hz
Load type	Resistive, inductive, lamp load
Switching voltage (max.)	100 VAC, 30 VDC
Switching current (max.)	0.5 A
Switching current (note)	0.5 A at 100 VAC; 1 A at 30 VDC
Switching voltage (min.)	0.01 V
Switching current (min.)	0.01 mA
Switching power	50 VA / 30 W
Pull-in time (max.)	4 ms
Drop-out time (max.)	4 ms
Electrical switching operations (min.) (at max. resistive load)	100 x 10 ³ switching operations
Mechanical switching operations (min.) (at max. resistive load)	100 x 10 ⁶ switching operations
Intrinsically safe Ex i	Yes
Output data width (internal) max.	2 bits
Supply voltage (system)	5 VDC; via data contacts
Current consumption (5 V system supply)	26 mA
Supply voltage (field)	24 VDC; (Ex i power supply: U _o = max. 26.8 V); via power jumper contacts (supply via blade contact; distribution via spring contact)
Current consumption, field supply (module with no external load)	24 mA
Power consumption P _{max}	0.8 W
Power loss P _I	0.8 W
Isolation	300 VAC system/supply
Number of incoming power jumper contacts	2
Number of outgoing power jumper contacts	2
Current carrying capacity (power jumper contacts)	1 A
Indicators	LED (A, E) green: Status relay 1, relay 2

Explosion protection

Identification	ATEX: II 3 (1) G Ex ec [ia Ga] IIC T4 Gc; II (1) D [Ex ia Da] IIIC; I (M1) [Ex ia Ma] I IECEX/INMETRO: Ex ec [ia Ga] IIC T4 Gc; [Ex ia Da] IIIC; [Ex ia Ma] I cULus (Zone classified): Cl I Zn 2 AEx nA [ia Ga] IIC T4 Gc; Cl I Zn 2 AEx nA [ia IIIC] IIC T4 Gc; Ex nA [ia Ga] IIC T4 Gc X; Ex nA [ia IIIC] IIC T4 Gc X cULus (Devison classified): Class I, Div. 2, Group A B C D, T4
Ex standard	EN IEC 60079-0, -7, -11
Safety-relevant data (circuit)	Relay output: U _i = 30 VDC; I _i = 1 A; P _i = 30 W; U ₁ = 100 VAC; I ₁ = 0.5 A; P ₁ = 50 VA; L ₁ = negligibly small; C ₁ = negligibly small. Both maximum switching current and voltage must comply with EN 60079-11.

Connection Data

Connection technology: I/O	6 x CAGE CLAMP®
Connectable conductor materials	Copper
Connection type	Inputs/outputs
Solid conductor	0.08 ... 2.5 mm ² / 28 ... 14 AWG
Fine-stranded conductor	0.08 ... 2.5 mm ² / 28 ... 14 AWG
Strip length	8 ... 9 mm / 0.31 ... 0.35 inches

Physical data

Width	12 mm / 0.472 inches
Height	100 mm / 3.937 inches
Depth	67.8 mm / 2.669 inches
Depth from upper-edge of DIN-rail	60.6 mm / 2.386 inches

Mechanical data

Mounting type	DIN-35 rail
---------------	-------------

Material data

Color	blue
Housing material	Polycarbonate; polyamide 6.6
Fire load	0.885 MJ
Weight	49.1 g
Conformity marking	CE

Environmental requirements

Ambient temperature (operation)	0 ... +55 °C
Ambient temperature (storage)	-25 ... +85 °C
Protection type	IP20
Pollution degree	2 per IEC 61131-2
Operating altitude	0 ... 2000 m / 0 ... 6562 ft
Mounting position	Horizontal left, horizontal right, horizontal top, horizontal bottom, vertical top and vertical bottom
Relative humidity (without condensation)	95 %
Vibration resistance	4g per IEC 60068-2-6
Shock resistance	15g per IEC 60068-2-27
EMC immunity to interference	per EN 61000-6-2, marine applications
EMC emission of interference	per EN 61000-6-3, marine applications
Exposure to pollutants	per IEC 60068-2-42 and IEC 60068-2-43
Permissible H ₂ S contaminant concentration at a relative humidity 75 %	10 ppm
Permissible SO ₂ contaminant concentration at a relative humidity 75 %	25 ppm

Commercial data

Product Group	15 (I/O System)
PU (SPU)	1 pcs
Packaging type	Box
Country of origin	DE
GTIN	4050821694823
Customs tariff number	85371098990

Product Classification	
UNSPSC	32101517
eCl@ss 10.0	27-24-26-04
eCl@ss 9.0	27-24-26-04
ETIM 9.0	EC001599
ETIM 10.0	EC001599
ECCN	NO US CLASSIFICATION

Environmental Product Compliance	
CAS-No.	1303-86-2 1317-36-8 7439-92-1
REACH Candidate List Substance	Diboron trioxide Lead Lead monoxide
RoHS Compliance Status	Compliant,With Exemption
RoHS Exemption	6(c) 7(a) 7(c)-I 7(c)-II
SCIP notification number (Austria)	d5f097b7-abf8-45ad-b3d6-b946671af2f4
SCIP notification number (Belgium)	bc938025-28c2-42df-b54b-e4afb7730e85
SCIP notification number (Bulgaria)	002bd186-d5e3-47b3-a7a0-0389c8b06f75
SCIP notification number (Czech Republic)	5a60556d-909a-4527-8f57-cb9a00d43af1
SCIP notification number (Denmark)	6022b4af-1510-49c7-a5c1-b9597d95f99e
SCIP notification number (Finland)	8a5098d3-6519-4d07-827a-b7bbeb879faa
SCIP notification number (France)	406fa678-d793-411e-a492-2067b6d1f6fd
SCIP notification number (Germany)	3c9d315e-a017-4d5c-91f8-d6a6defebaf3
SCIP notification number (Hungary)	06717bb8-38dd-42c6-8d6a-45e1ce22fe4e
SCIP notification number (Italy)	e749c4cb-46c1-49e0-af72-1f7934257865
SCIP notification number (Netherlands)	f9ba7bbb-cfc3-498a-b3b2-912cd79b6bcf
SCIP notification number (Poland)	058fa26f-3bef-4e58-bcab-a083d9b032cf
SCIP notification number (Romania)	72236ad5-6438-41d5-a481-598ef0fdf16d
SCIP notification number (Sweden)	3a2c1934-049e-4915-848c-d5761f0faec8

Approvals / Certificates

General approvals



Approval	Standard	Certificate Name
EAC GZO Almaty Standart	TP TC 004/2011	EAC CoC 03080
EAC GZO Almaty Standart	TP TC 020/2011	EAC CoC 03083
KC National Radio Research Agency	Article 58-2, Clause 3	MSIP-REM-W43-DOM750
UL Underwriters Laboratories Inc. (ORDINARY LOCATIONS)	UL 508	E175199

Declarations of conformity and manufacturer's declarations

Approval	Standard	Certificate Name
EU-Ex-Declaration of Conformity WAGO GmbH & Co. KG	-	-

Approvals for marine applications



Approval	Standard	Certificate Name
ABS American Bureau of Shipping	-	22-2219060
DNV DNV GL SE	DNV-CG-0339, Aug. 2021	TAA0000194
KR Korean Register of Shipping	-	KR HMB05880-AC001
LR Lloyds Register EMEA	-	LR22180952TA
PRS Polski Rejestr Statków	-	TE/1101/880590/23
RINA RINA Germany GmbH	-	ELE343521XG001

Approvals for hazardous areas



Approval	Standard	Certificate Name
AEx UL International Germany GmbH	UL 60079	E480271
ATEX TUEV Nord Cert GmbH	EN 60079-0	TUEV12ATEX106032X (Ex ec[iaGa] IIC T4 Gc, [Ex ia-Da] IIIC, [Ex iaMa] I)
CCC CNEX	CNCA-C23-01	2020312310000211 (Ex ec[iaGa] IIC T4 Gc, [Ex ia-Da] IIIC, [Ex iaMa] I)
IECEX TUEV Nord Cert GmbH	IEC 60079	IECEX TUN12.0039X (Ex ec[iaGa] IIC T4 Gc, [Ex ia-Da] IIIC, [Ex iaMa] I)
INMETRO TÜV Rheinland do Brasil Ltda.	-	TÜV_14.1911_X
UKEx Element Materials Technology UK	-	EMA21UKEX0069X
UL Underwriters Laboratories Inc. (HAZARDOUS LOCATIONS)	UL 121201	E198726

Downloads

Environmental Product Compliance

Compliance Search
Environmental Product Compliance 750-538 ↓

Documentation

Manual			
System Manual Series 750/753			↓
Product Manual 2-channel, Relay Output Module 100V AC, 30 V DC, Ex i	2484922251 2 en-US 2025-09-11 11:31	pdf 1005.17 KB	↓

System Description		
750/753 Series I/O-System – General Product Information	pdf 953.35 KB	↓
Overview on WAGO-I/O-SYSTEM 750 approvals	pdf 770.48 KB	↓
Ex i Overview	pdf 442.07 KB	↓

Bid Text			
750-538	19.02.2019	xml 5.91 KB	↓
750-538	06.10.2017	doc 29.50 KB	↓

Instruction Leaflet			
CCC Ex (Additional information)	26.04.2023	pdf 143.96 KB	↓









CAD/CAE-Data	
CAD data	CAE data
2D/3D Models 750-538 ↓	EPLAN Data Portal 750-538 ↓
	WSCAD Universe 750-538 ↓
	ZUKEN Portal 750-538 ↓

1 Compatible Products

1.1 Optional Accessories

1.1.1 DIN-rail

1.1.1.1 Mounting accessories









 Item No.: 210-196 Aluminum carrier rail; 35 x 8.2 mm; 1.6 mm thick; 2 m long; unslotted; similar to EN 60715; silver-colored	 Item No.: 210-198 Copper carrier rail; 35 x 15 mm; 2.3 mm thick; 2 m long; unslotted; according to EN 60715; copper-colored	 Item No.: 210-197 Steel carrier rail; 35 x 15 mm; 1.5 mm thick; 2 m long; slotted; similar to EN 60715; silver-colored	 Item No.: 210-114 Steel carrier rail; 35 x 15 mm; 1.5 mm thick; 2 m long; unslotted; similar to EN 60715; silver-colored
 Item No.: 210-118 Steel carrier rail; 35 x 15 mm; 2.3 mm thick; 2 m long; unslotted; according to EN 60715; silver-colored	 Item No.: 210-115 Steel carrier rail; 35 x 7.5 mm; 1 mm thick; 2 m long; slotted; according to EN 60715; "Hole width 18 mm; silver-colored	 Item No.: 210-112 Steel carrier rail; 35 x 7.5 mm; 1 mm thick; 2 m long; slotted; according to EN 60715; "Hole width 25 mm; silver-colored	 Item No.: 210-113 Steel carrier rail; 35 x 7.5 mm; 1 mm thick; 2 m long; unslotted; according to EN 60715; silver-colored

1.1.2 Marking

1.1.2.1 Group marker carrier

 Item No.: 750-107 Group marker carrier

1.1.2.2 Marker

 Item No.: 2009-145/000-006 Mini-WSB Inline; for Smart Printer; 1700 pieces on roll; stretchable 5 - 5.2 mm; plain; snap-on type; blue	 Item No.: 2009-145/000-007 Mini-WSB Inline; for Smart Printer; 1700 pieces on roll; stretchable 5 - 5.2 mm; plain; snap-on type; gray	 Item No.: 2009-145/000-023 Mini-WSB Inline; for Smart Printer; 1700 pieces on roll; stretchable 5 - 5.2 mm; plain; snap-on type; green	 Item No.: 2009-145/000-012 Mini-WSB Inline; for Smart Printer; 1700 pieces on roll; stretchable 5 - 5.2 mm; plain; snap-on type; orange
 Item No.: 2009-145/000-005 Mini-WSB Inline; for Smart Printer; 1700 pieces on roll; stretchable 5 - 5.2 mm; plain; snap-on type; red	 Item No.: 2009-145/000-024 Mini-WSB Inline; for Smart Printer; 1700 pieces on roll; stretchable 5 - 5.2 mm; plain; snap-on type; violet	 Item No.: 2009-145 Mini-WSB Inline; for Smart Printer; 1700 pieces on roll; stretchable 5 - 5.2 mm; plain; snap-on type; white	 Item No.: 2009-145/000-002 Mini-WSB Inline; for Smart Printer; 1700 pieces on roll; stretchable 5 - 5.2 mm; plain; snap-on type; yellow

1.1.2.2 Marker



Item No.: 248-501/000-006

Mini-WSB marking card; as card; not stretchable; plain; snap-on type; blue



Item No.: 248-501/000-007

Mini-WSB marking card; as card; not stretchable; plain; snap-on type; gray



Item No.: 248-501/000-023

Mini-WSB marking card; as card; not stretchable; plain; snap-on type; green



Item No.: 248-501/000-017

Mini-WSB marking card; as card; not stretchable; plain; snap-on type; light green



Item No.: 248-501/000-012

Mini-WSB marking card; as card; not stretchable; plain; snap-on type; orange



Item No.: 248-501/000-005

Mini-WSB marking card; as card; not stretchable; plain; snap-on type; red



Item No.: 248-501/000-024

Mini-WSB marking card; as card; not stretchable; plain; snap-on type; violet



Item No.: 248-501

Mini-WSB marking card; as card; not stretchable; plain; snap-on type; white



Item No.: 248-501/000-002

Mini-WSB marking card; as card; not stretchable; plain; snap-on type; yellow

1.1.2.3 Marker carrier



Item No.: 750-103

Group marker carrier

1.1.3 Shield termination

1.1.3.1 Shield clamping saddles



Item No.: 790-108

Shield clamping saddle; 11 mm wide; diameter of compatible conductor; 3 ... 8 mm



Item No.: 790-208

Shield clamping saddle; 12.4 mm wide; 3 ... 8 mm



Item No.: 790-116

Shield clamping saddle; 19 mm wide; diameter of compatible conductor; 7 ... 16 mm



Item No.: 790-216

Shield clamping saddle; 21.8 mm wide; 6 ... 16 mm



Item No.: 790-124

Shield clamping saddle; 27 mm wide; diameter of compatible conductor; 6 ... 24 mm



Item No.: 790-220

Shield clamping saddle; 30 mm wide; 6 ... 20 mm



Item No.: 790-140

Shield clamping saddle; diameter of compatible conductor

1.1.4 Supply module

1.1.4.1 Supply module



Item No.: 750-606

Power Supply; 24 VDC; Diagnostics; Intrinsically safe



Item No.: 750-625/000-001

Power Supply; 24 VDC; Intrinsically safe