



## Recessed Floor Boxes for Concrete

RFBA2C, RFBA4C, RFBA6C, RFBA10C

RFBA Series of Floor Boxes with round activations are versatile recessed activation solutions that provide power, communication and/or audio/video services to open space areas, or directly to workstations. The floor boxes come in various sizes and depths, including 2, 4, 6 and 10-gangs to best fit your specific application. The round activation boxes utilize existing Evolution™ series round covers and are designed to sit on top or flush with finished floor surfaces, such as carpet, tile, wood flooring, polished concrete or terrazzo. The RFBA series includes improved wire and cable routing, allowing for easier wire pulling in adjacent compartments and around corners.

The RFBA floor box is built for multiple applications and environments

### Features & Benefits

- **Suitable for Various Applications.** Steel and on-grade (epoxy coated) to meet your specific installation requirements with support for installation in carpet, wood flooring, tile, terrazzo and polished concrete.
- **Various Gang and Depth Options Available.** Choose from either 2, 4, 6 or 10-gang boxes to fit your application. The 2 and 4-gang options are available in either a shallow (3.25") depth or standard (3.75") depth box.
- **Common Mounting Plates.** All models share the same mounting plates, allowing for easier configuration and specification.
- **Numerous Conduit Knockouts.** Features knockouts on all sides and bottom of box to allow for greater installation flexibility to work within your environment.
- **Utilizes Evolution™ Series Round Covers.** Choose from a wide range of die-cast aluminum cover assemblies, available in powder coated finishes of black, gray and bronze, as well as durable finishes with brushed aluminum, satin brass plated and satin nickel plated.
- **Improved Cable Management.** Internal compartments feature improved wire and cable routing for easier wire pulling in adjacent compartments and around corners.
- **Post-Pour Features:** Allows for adjustment post-pour and features removable dividers that can be installed or removed before or after the concrete pour.

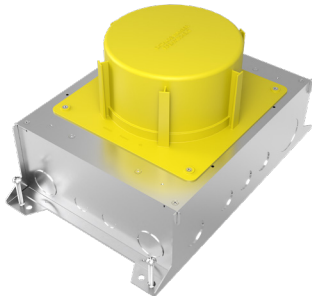

Round extension ring can be used to extend height of box up to 4 inches

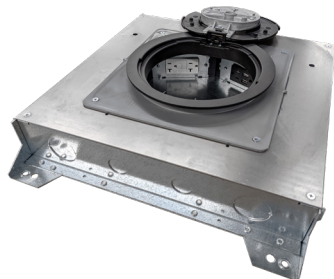

All models share eight (8) common device plates, allowing for data and power within the same box



Compatible with existing Evolution Series die-cast aluminum covers. Choose from powder coated finishes or durable finishes.

### Compliance



cULus Listed: Metallic Outlet Boxes for tile, terrazzo, carpet and wood floors.  
File E2961 Guide QCIT

## RFBA Series Round Activation Floor Boxes Ordering Information

| Box Model   | Box Type    | Box Capacity | Box Depth | Conduit Size | Cover Style               |
|-------------|-------------|--------------|-----------|--------------|---------------------------|
| RFBA2C25    | Above Grade | 2-Gang       | 3.25"     | ¾" - 1 ¼"    | Evolution 6" Round Covers |
| RFBA2C25OG  | On-Grade    | 2-Gang       | 3.25"     | ¾" - 1 ¼"    | Evolution 6" Round Covers |
| RFBA2C30    | Above Grade | 2-Gang       | 3.75"     | ¾" - 2"*     | Evolution 6" Round Covers |
| RFBA2C30OG  | On-Grade    | 2-Gang       | 3.75"     | ¾" - 2"*     | Evolution 6" Round Covers |
| RFBA4C25    | Above Grade | 4-Gang       | 3.25"     | ¾" - 1 ½"    | Evolution 6" Round Covers |
| RFBA4C25OG  | On-Grade    | 4-Gang       | 3.25"     | ¾" - 1 ½"    | Evolution 6" Round Covers |
| RFBA4C30    | Above Grade | 4-Gang       | 3.75"     | ¾" - 2"*     | Evolution 6" Round Covers |
| RFBA4C30OG  | On-Grade    | 4-Gang       | 3.75"     | ¾" - 2"*     | Evolution 6" Round Covers |
| RFBA6C30    | Above Grade | 6-Gang       | 3.75"     | ¾" - 2"*     | Evolution 8" Round Covers |
| RFBA6C30OG  | On-Grade    | 6-Gang       | 3.75"     | ¾" - 2"*     | Evolution 8" Round Covers |
| RFBA10C55   | Above Grade | 10-Gang      | 6.25"     | ¾" - 2"      | Evolution 8" Round Covers |
| RFBA10C55OG | On-Grade    | 10-Gang      | 6.25"     | ¾" - 2"      | Evolution 8" Round Covers |

\* Additional 2HUB accessory is needed on the 2, 4 and 6-gang boxes if using a 2" conduit feed to the box. Largest knockout without the 2HUB accessory on the 2, 4 and 6-gang boxes is 1 ¼".

## RFBA Series Round Activation Floor Boxes Ordering Information

### RFBA2C25

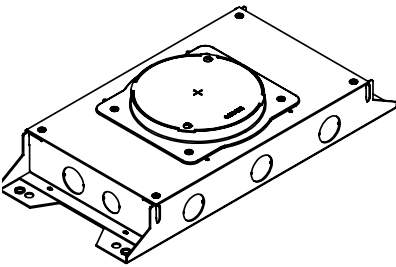

**RFBA 2-Gang Round Floor Box, Shallow 3.25" Depth** – Steel floor box designed for above grade installations. Features 2-gangs of box capacity with at least 3 ⅛" available behind device plates. Fully adjustable before and after concrete pour. Designed for carpet, wood flooring, tile, terrazzo and polished concrete and applications. Use with Evolution™ Series 6" round covers. When ordering device plates for box, 2 blank device plates (Cat. No. RFBAB) must also be ordered to seal of wire and cable routing passageways.

**Concrete Pour:** Minimum concrete pour is 3.25"

Sold Separately:

- Evolution™ Series 6CTC & 6CT Round Covers
- Device Plates

### RFBA2C25OG

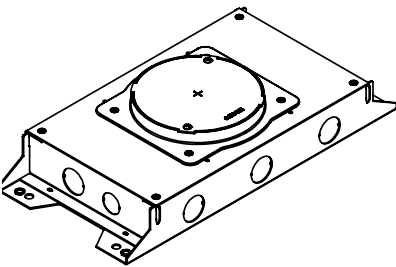

**RFBA 2-Gang On-Grade Round Floor Box, Shallow 3.25" Depth** – Steel floor box designed for on-grade installations with a fusion-bonded epoxy for use on metal reinforcement bar and related accessories before encapsulating in concrete. Features 2-gangs of box capacity with at least 3 ⅛" available behind device plates. Fully adjustable before and after concrete pour. Designed for carpet, wood flooring, tile, terrazzo and polished concrete applications. Use with Evolution™ Series 6" round covers. When ordering device plates for box, 2 blank device plates (Cat. No. RFBAB) must also be ordered to seal of wire and cable routing passageways.

**Concrete Pour:** Minimum concrete pour is 3.25"

Sold Separately:

- Evolution™ Series 6CTC & 6CT Round Covers
- Device Plates

### Dimensions:

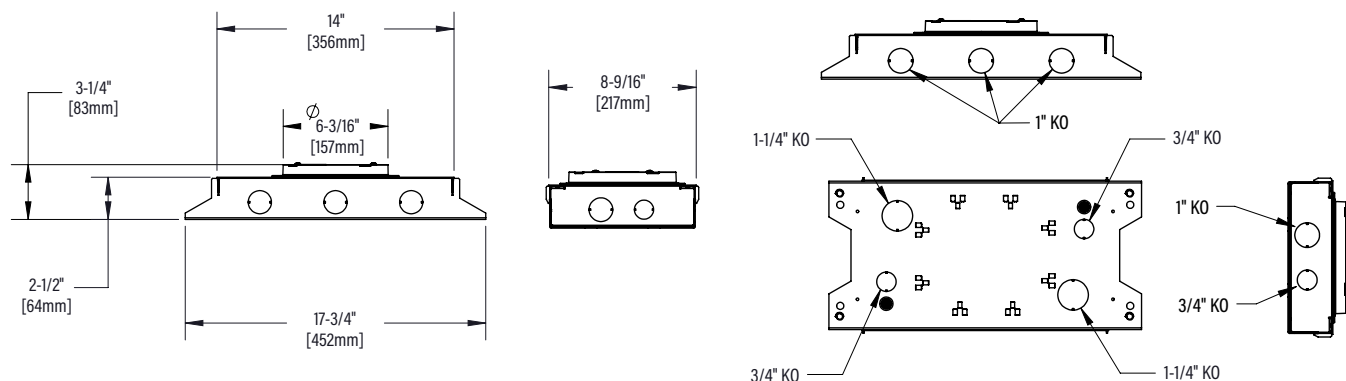

## RFBA Series Round Activation Floor Boxes Ordering Information

### RFBA2C30

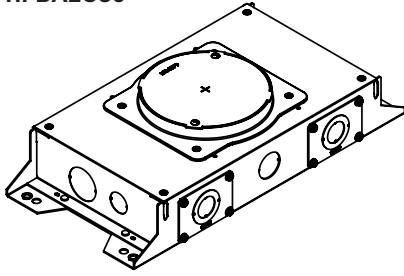

**RFBA 2-Gang Round Floor Box, Standard 3.75" Depth** – Steel floor box designed for above grade installations. Features 2-gangs of box capacity with at least 3 1/16" available behind device plates. Fully adjustable before and after concrete pour. Designed for carpet, wood flooring, tile, terrazzo and polished concrete applications. Use with Evolution™ Series 6" round covers. When ordering device plates for box, 2 blank device plates (Cat. No. RFBAB) must also be ordered to seal of wire and cable routing passageways.

**Concrete Pour:** Minimum concrete pour is 3.75"

Sold Separately:

- Evolution™ Series 6CTC & 6CT Round Covers
- Device Plates

### RFBA2C30OG RFBA2C30OG-NA\*

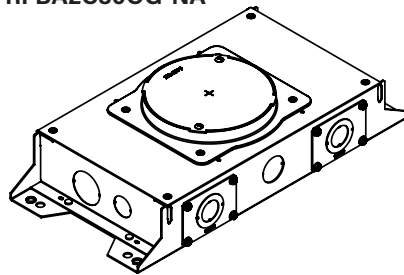

**RFBA 2-Gang On-Grade Round Floor Box, Standard 3.75" Depth** – Steel floor box designed for on-grade installations with a fusion-bonded epoxy for use on metal reinforcement bar and related accessories before encapsulating in concrete. Features 2-gangs of box capacity with at least 3 1/16" available behind device plates. Fully adjustable before and after concrete pour. Designed for carpet, wood flooring, tile, terrazzo and polished concrete applications. Use with Evolution™ Series 6" round covers. When ordering device plates for box, 2 blank device plates (Cat. No. RFBAB) must also be ordered to seal of wire and cable routing passageways.

**Concrete Pour:** Minimum concrete pour is 3.75"

Sold Separately:

- Evolution™ Series 6CTC & 6CT Round Covers
- Device Plates

\*OG version available as BAA compliant product by adding -NA

## Dimensions:

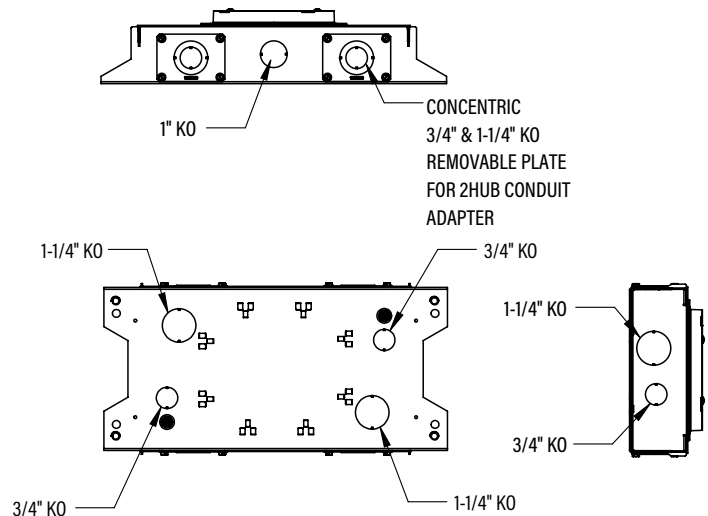
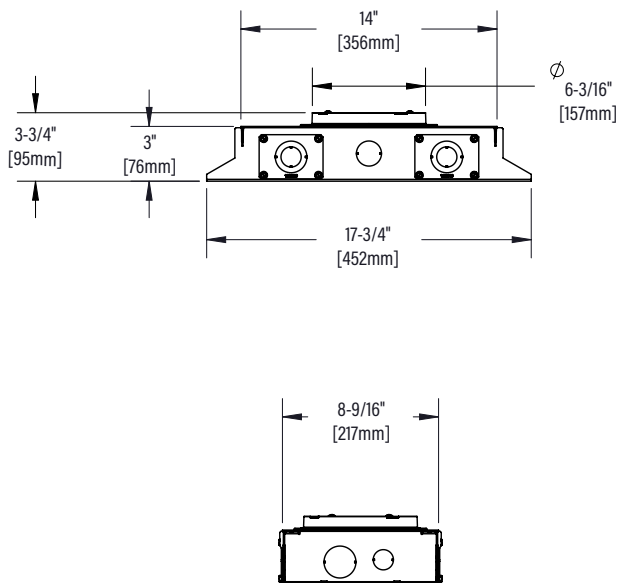

## RFBA Series Round Activation Floor Boxes Ordering Information

### RFBA4C25

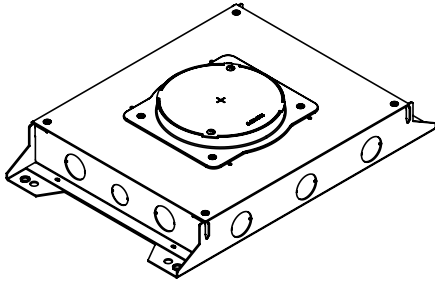

**RFBA 4-Gang Round Floor Box, Shallow 3.25" Depth** - Steel floor box designed for above grade installations. Features 4-gangs of box capacity with at least 2 9/16" available behind device plates. Fully adjustable before and after concrete pour. Designed for carpet, wood flooring, tile, terrazzo and polished concrete applications. Use with Evolution™ Series 6" round covers.

**Concrete Pour:** Minimum concrete pour is 3.25"

Sold Separately:

- Evolution™ Series 6CTC & 6CT Round Covers
- Device Plates

### RFBA4C25OG

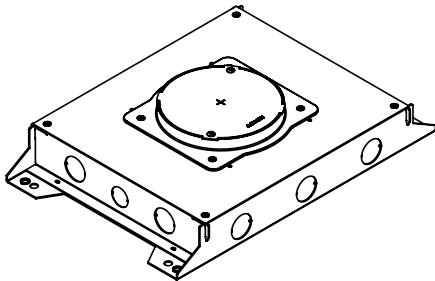

**RFBA 4-Gang On-Grade Round Floor Box, Shallow 3.25" Depth** - Steel floor box designed for on-grade installations with a fusion-bonded epoxy for use on metal reinforcement bar and related accessories before encapsulating in concrete. Features 4-gangs of box capacity with at least 2 9/16" available behind device plates. Fully adjustable before and after concrete pour. Designed for carpet, wood flooring, tile, terrazzo and polished concrete applications. Use with Evolution™ Series 6" round covers.

**Concrete Pour:** Minimum concrete pour is 3.25"

Sold Separately:

- Evolution™ Series 6CTC & 6CT Round Covers
- Device Plates

## Dimensions:

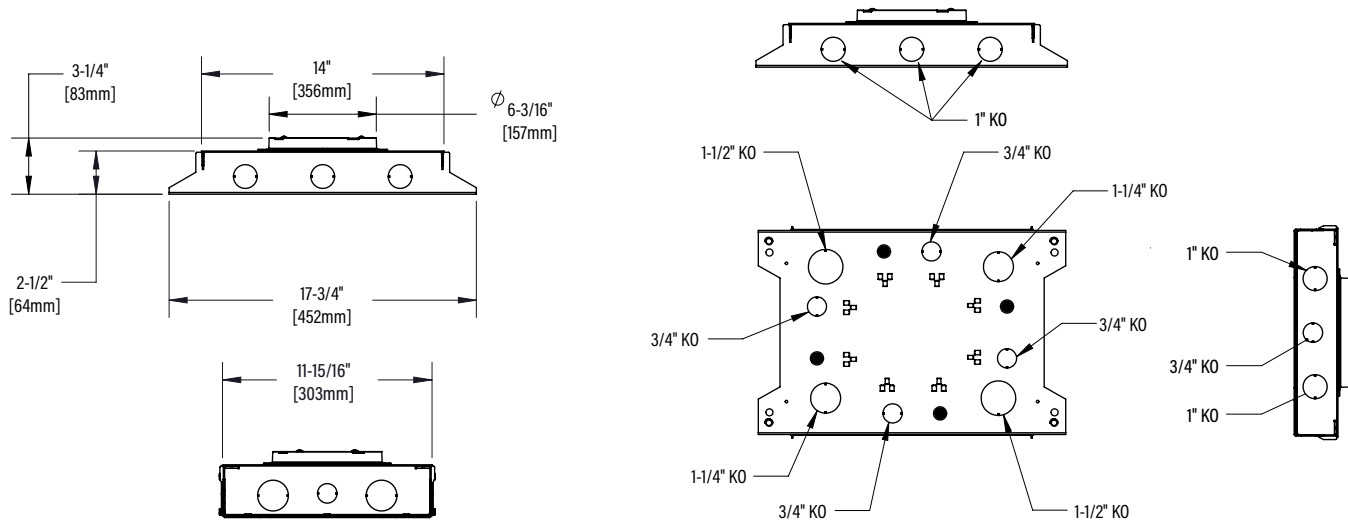

## RFBA Series Round Activations Floor Boxes Ordering Information

### RFBA4C30

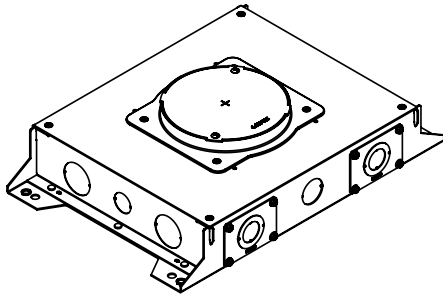

**RFBA 4-Gang Round Floor Box, Standard 3.75" Depth** - Steel floor box designed for above grade installations. Features 4-gangs of box capacity with at least 2 9/16" available behind device plates. Fully adjustable before and after concrete pour. Designed for carpet, wood flooring, tile, terrazzo and polished concrete applications. Use with Evolution™ Series 6" round covers.

**Concrete Pour:** Minimum concrete pour is 3.75"

Sold Separately:

- Evolution™ Series 6CTC & 6CT Round Covers
- Device Plates

### RFBA4C30OG RFBA4C30OG-NA\*

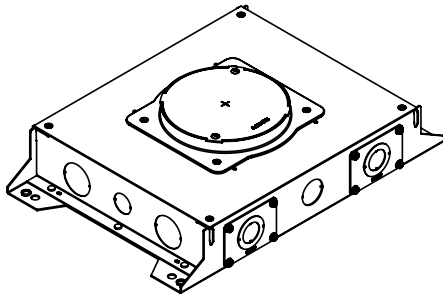

**RFBA 4-Gang On-Grade Round Floor Box, Standard 3.75" Depth** - Steel floor box designed for on-grade installations with a fusion-bonded epoxy for use on metal reinforcement bar and related accessories before encapsulating in concrete. Features 4-gangs of box capacity with at least 2 9/16" available behind device plates. Fully adjustable before and after concrete pour. Designed for carpet, wood flooring, tile, terrazzo and polished concrete applications. Use with Evolution™ Series 6" round covers.

**Concrete Pour:** Minimum concrete pour is 3.75"

Sold Separately:

- Evolution™ Series 6CTC & 6CT Round Covers
- Device Plates

\*OG version available as BAA compliant product by adding -NA

## Dimensions:

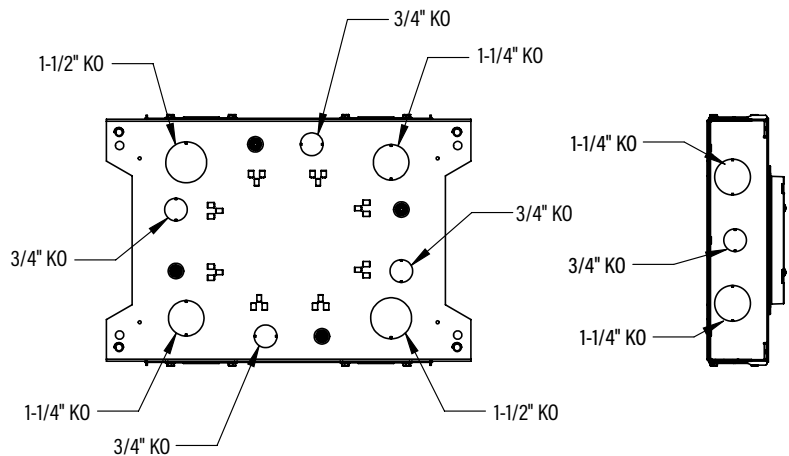
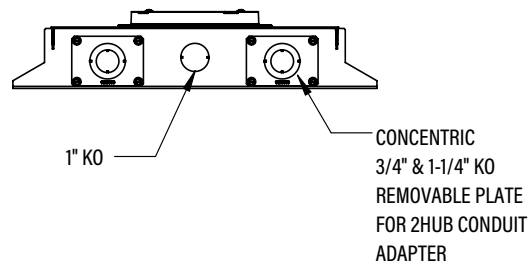
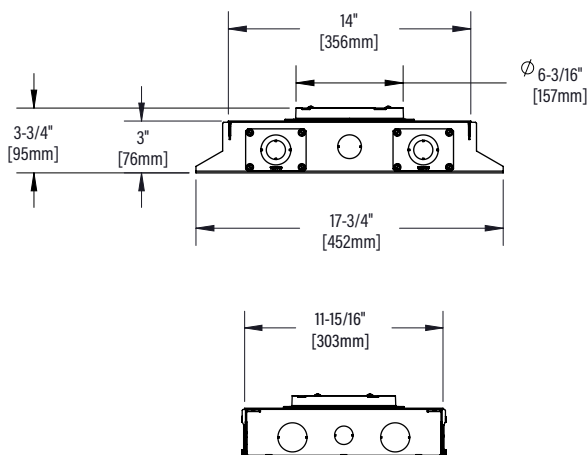

**RFBA Series Round Activation Floor Boxes Ordering Information**

**RFBA6C30**

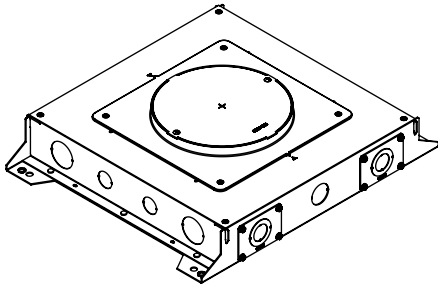

**RFBA 6-Gang Round Floor Box, Standard 3.75" Depth** - Steel floor box designed for above grade installations. Features 6-gangs of box capacity with at least 2 9/16" available behind device plates. Fully adjustable before and after concrete pour. Designed for carpet, wood flooring, tile, terrazzo and polished concrete applications. Use with Evolution™ Series 8" round covers.

**Concrete Pour:** Minimum concrete pour is 3.75"

Sold Separately:

- Evolution™ Series 8CTC & 8CT Round Covers
- Device Plates

**RFBA6C30OG**  
**RFBA6C30OG-NA\***

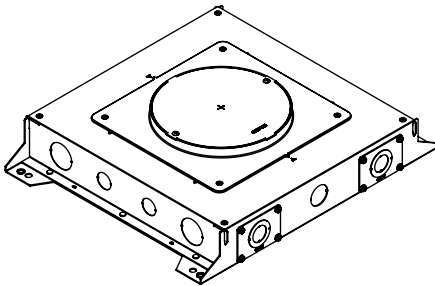

**RFBA 6-Gang Round On-Grade Floor Box, Standard 3.75" Depth** - Steel floor box designed for on-grade installations with a fusion-bonded epoxy for use on metal reinforcement bar and related accessories before encapsulating in concrete. Features 6-gangs of box capacity with at least 2 9/16" available behind device plates. Fully adjustable before and after concrete pour. Designed for carpet, wood flooring, tile, terrazzo and polished concrete applications. Use with Evolution™ Series 8" round covers.

**Concrete Pour:** Minimum concrete pour is 3.75"

Sold Separately:

- Evolution™ Series 8CTC & 8CT Round Covers
- Device Plates

\*OG version available as BAA compliant product by adding -NA

**Dimensions:**

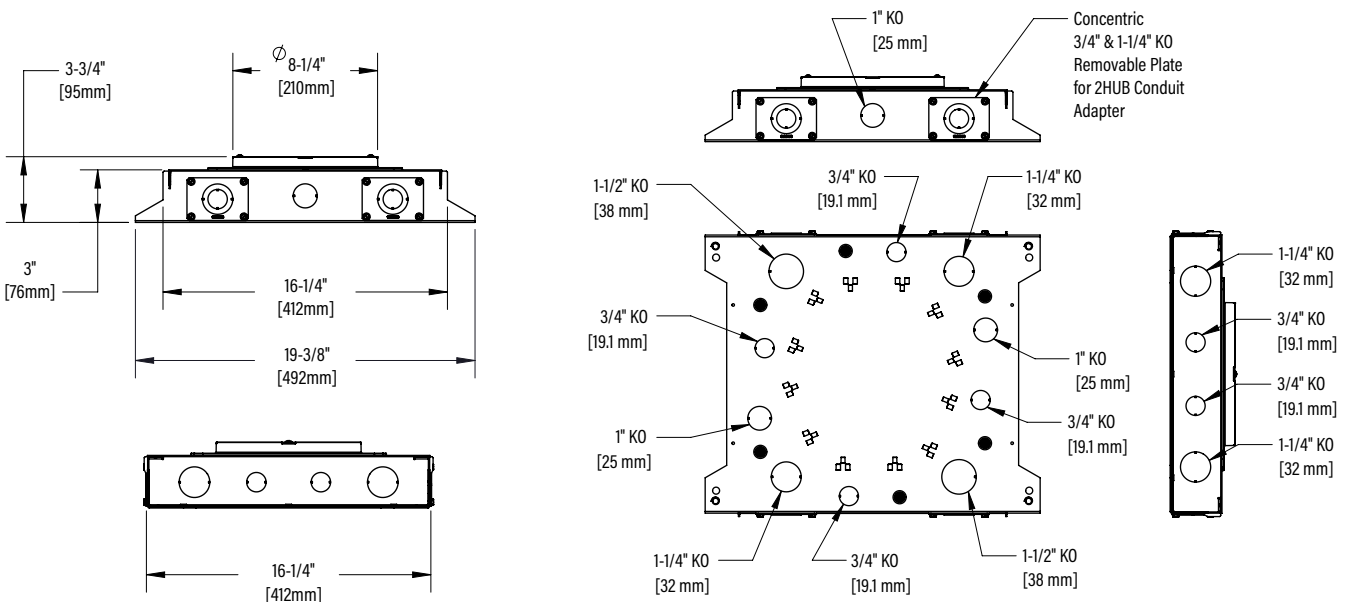

## RFBA Series Round Activation Floor Boxes Ordering Information

### RFBA10C55

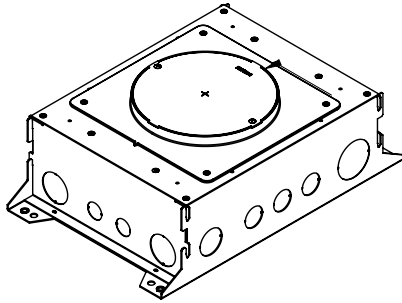

**RFBA 10-Gang Round Floor Box, 6.25" Depth** - Steel floor box designed for above grade installations. Features 10-gangs of box capacity with at least 2 ½" available behind device plates. Fully adjustable before and after concrete pour. Designed for carpet, wood flooring, tile, terrazzo and polished concrete applications. Use with Evolution™ Series 8" round covers.

Sold Separately:

- Evolution™ Series 8CTC & 8CT Round Covers
- Device Plates

### RFBA10C55OG RFBA10C55OG-NA\*

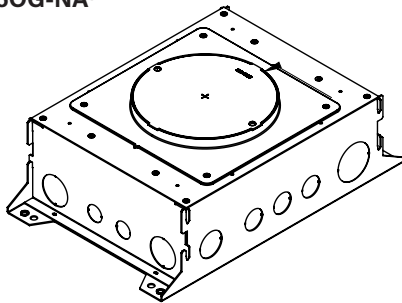

**RFBA 10-Gang Round On-Grade Floor Box, 6.25" Depth** - Steel floor box designed for on-grade installations with a fusion-bonded epoxy for use on metal reinforcement bar and related accessories before encapsulating in concrete. Features 10-gangs of box capacity with at least 2 ½" available behind device plates. Fully adjustable before and after concrete pour. Designed for carpet, wood flooring, tile, terrazzo and polished concrete applications. Use with Evolution™ Series 8" round covers.

**Concrete Pour:** Minimum concrete pour is 6.25"

Sold Separately:

- Evolution™ Series 8CTC & 8CT Round Covers
- Device Plates

\*OG version available as BAA compliant product by adding -NA

### Dimensions:

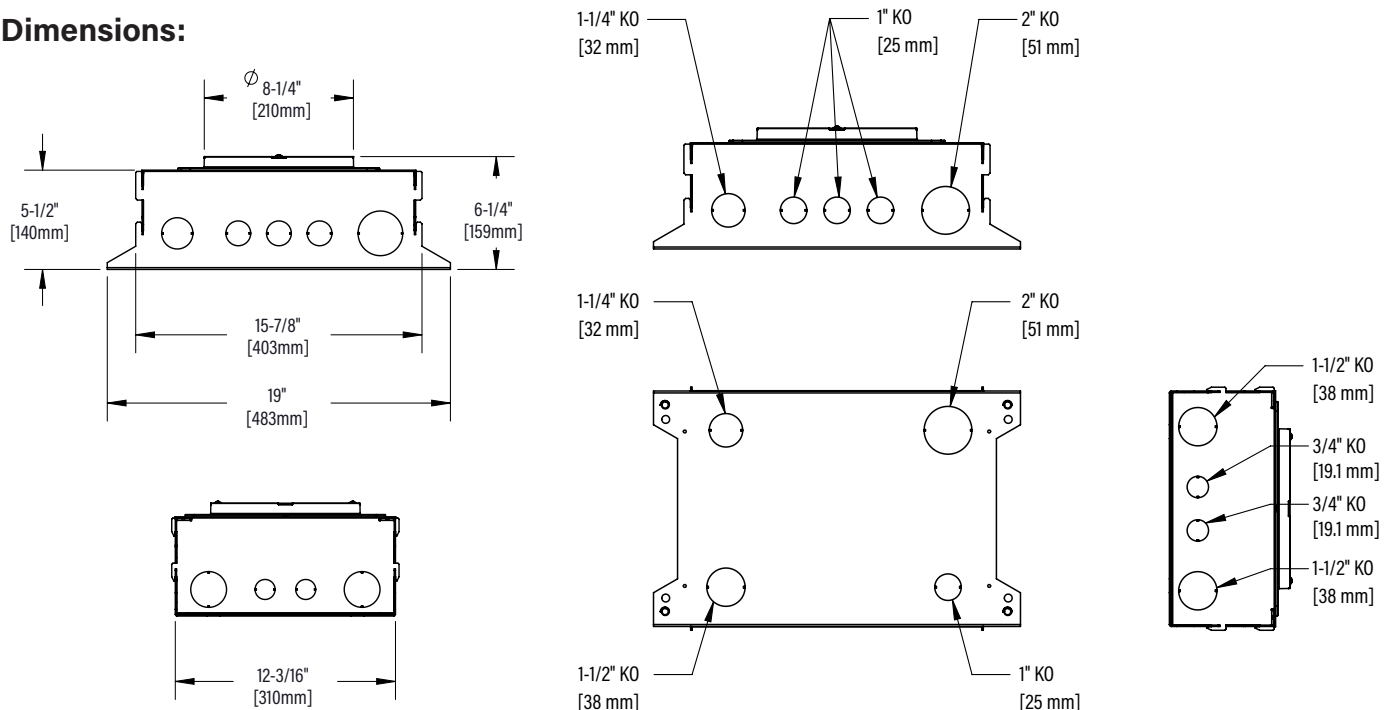

**RFBA Series Round Activation Floor Boxes Accessories Ordering Information**

**RFBAB**

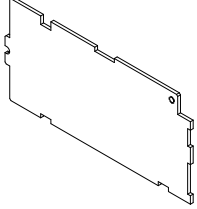

**Blank Device Plate** - Closes off unused gangs.

**RFBAS2**

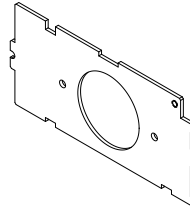

**1.59" Single Device Plate** - Receptacle opening 1 9/16" (40mm)

**RFBADP**

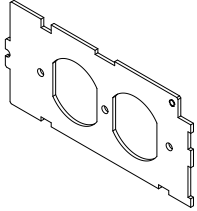

**Duplex Device Plate** - Accepts standard 15 Amp & 20 Amp Duplex Receptacles.

**RFBA6A**

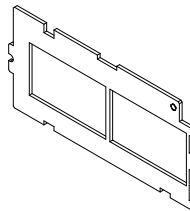

**Communications Plate** - Accepts bezels for common communications devices. Including TracJack, Series II, Keystone, Lucent

**RFBADP20TR**

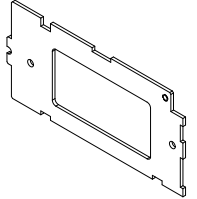

**Decorator Device Plate** - Accepts Decorator Style Receptacles, Communication or A/V Devices.

**RFBA6AAP**

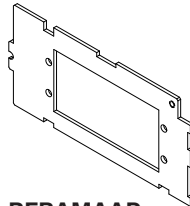

**AAP Device Plate** - Accepts Extron® Electronics AAP devices (sold separately)

**RFBADEC**

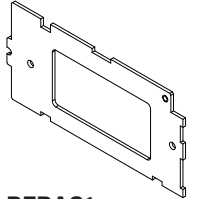

**Decorator Device Plate** - Accepts Decorator Style Receptacles, Communication or A/V Devices.

**RFBAMAAP**

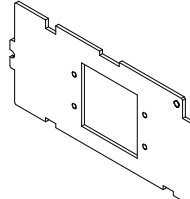

**MAAP Device Plate** - Accepts two (2) Legrand AVIP or Extron® Electronics MAAP Series Devices (sold separately)

**RFBAS1**

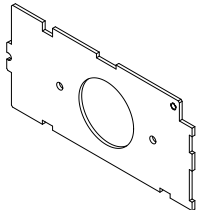

**1.39" Single Device Plate** - Receptacle opening 1 3/8" (35mm)

**RFBA610C4EXT**

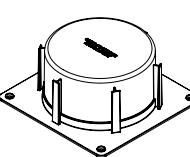

**4" Round Extension Ring for 6/10-gang Floor Boxes** - Used to extend height of floor box. Cut to desired level after concrete pour.

**RFBA24C4EXT**

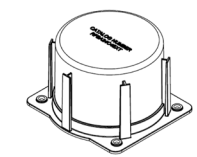

**4" Round Extension Ring for 2/4-gang Floor Boxes** - Used to extend height of floor box. Cut to desired level after concrete pour.

**RFBAC24FF**

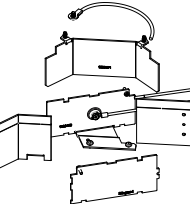

**Furniture Feed Barrier Kit for 2 and 4-Gang Boxes** - Used to separate power and communication services. Used in combination with 6" Evolution Series Furniture Feed Covers (6CFFTC). Covers sold separately

**2HUB**

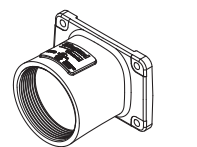

**2" Conduit Transition Hub** - Trade size 2" die cast zinc conduit fitting allows for 2" conduit to transition into a shallow box design. Includes: die cast fitting, gasket, and mounting screws.

**RFBADJ4LB**

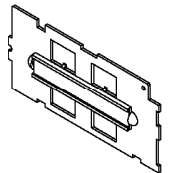

**Device Mounting Plate** - Accepts 4 jacks of data and includes removable label holder and labels

**RFBA10-2G**

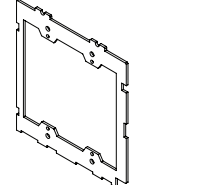

**2-Gang Adapter Plate for 10-Gang Box**

**RFBA10-3G**

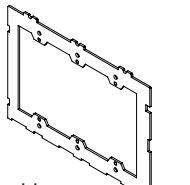

**3-Gang Adapter Plate for 10-Gang Box**



**Evolution Series 6" Cover Assemblies Ordering Information - Use with 2 and 4-Gang RFBAC**

| Catalog No./Item   | Description/Specifications  | Catalog No./Item   | Description/Specifications   |
|--|---|--|--|
| <p><b>Powder Coat Finishes</b><br/>6CTC2BK<br/>6CTC2GY<br/>6CTC2BZ</p> <p><b>Durable Finishes</b><br/>6CTC2AA*<br/>6CTC2SB*<br/>6CTC2SN*</p> <p><b>*NOTE:</b> Durable finishes are available as BAA product with -NA suffix.</p> | <p><b>Surface Style Cover Assembly -</b> Low profile cover designed to attach to the 2 and 4-gang RFBA round activation floor boxes. Each cover is made from die-cast aluminum materials and equipped with a durable hinge which allows the cover to rotate open 180°, two (2) slide egress doors that lock in the open position and auto-close around the cables when the covers are closed, and an 8° beveled edge that meets ADA guidelines and reduces tripping hazards. These covers are designed to sit on top of finished floor surfaces such as: carpet, tile, wood, polished concrete, and terrazzo. Available in three (3) aesthetic powder coated finishes: black (BK), gray (GY), bronze (BZ) and three durable finishes: brushed aluminum (AA), satin brass plated (SB), and satin nickel plated (SN).</p> | <p><b>Powder Coat Finishes</b><br/>6CTC2BKTR<br/>6CTC2GYTR<br/>6CTC2BZTR</p> <p><b>Durable Finishes</b><br/>6CTC2AATR*<br/>6CTC2SBTR*<br/>6CTC2SNTR*</p> <p><b>*NOTE:</b> Durable finishes are available as BAA product with -NA suffix.</p> | <p><b>Tamper-Resistant Surface Style Cover Assembly -</b> Low profile cover designed to attach to the 2 and 4-gang RFBA round activation floor boxes. Each cover is made from die-cast aluminum materials and equipped with a durable hinge which allows the cover to rotate open 180°, two (2) slide egress doors that lock in the open position and auto-close around the cables when the covers are closed, and an 8° beveled edge that meets ADA guidelines and reduces tripping hazards. These covers are designed to sit on top of finished floor surfaces such as: carpet, tile, wood, polished concrete, and terrazzo. Available in three (3) aesthetic powder coated finishes: black (BK), gray (GY), bronze (BZ) and three durable finishes: brushed aluminum (AA), satin brass plated (SB), and satin nickel plated (SN).</p> |

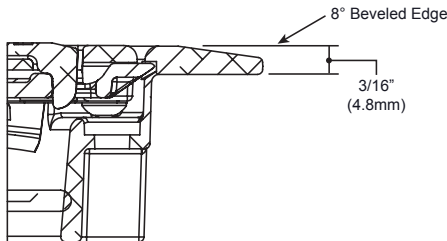
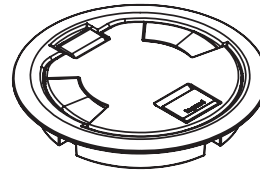
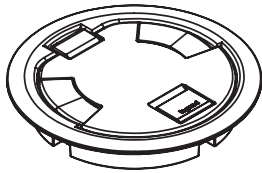

|   |  |
|---|--|
| <p><b>Powder Coat Finishes</b><br/>6CFFTCBK<br/>6CFFTCGY<br/>6CFFTCBZ</p> <p><b>Durable Finishes</b><br/>6CFFTCAA<br/>6CFFTCSB<br/>6CFFTCSN</p> | <p><b>Furniture Feed Cover Assembly -</b> Surface style, die-cast aluminum cover assembly, with one (1) 3/4" trade size screw plug opening, and one (1) concentric 2"-1 1/4" trade size screw plug opening and one (1) divider to separate services. Cover assembly is available in three (3) powder coated finishes: black (BK), gray(GY), bronze (BZ) and also available in three (3) durable finishes: brushed aluminum (AA), satin brass plated (SB) and satin nickel plated (SN). 6CFFTC Series Cover Assemblies designed for use 2 and 4-gang RFBA round activation floor boxes.</p> |
|---|--|

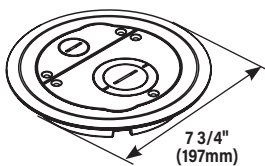

**Evolution Series 6" Cover Assemblies Ordering Information - Use with 2 and 4-Gang RFBA**

| Catalog No./Item | Description/Specifications   | Catalog No./Item | Description/Specifications   |
|------------------|--|------------------|--|
| <b>6CT-CTR</b>   | <b>6" Terrazzo Ring</b> - Nonmetallic ring for use on terrazzo floor applications. Compatible with the 2 and 4-gang RFBA round activation floor boxes. | <b>6TS</b>       | <b>Tile Shim</b> - Used for floor coverings greater than 3/16" (4.8mm). The 6TS will allow the top surface of the cover to be flush with the finished floor. Includes: six (6) 1/16" (1.6mm) thick shims. Up to a total of 3/8" (9.5mm) of adjustment. |

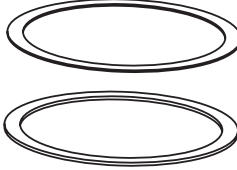
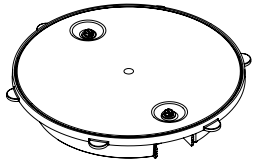

| Catalog No./Item  | Description/Specifications  | Catalog No./Item  | Description/Specifications   |
|---|---|---|--|
| <b>Powder Coat Finishes</b><br><b>6CT2BK</b><br><b>6CT2GY</b><br><b>6CT2BZ</b><br><br><b>Durable Finishes</b><br><b>6CT2AA*</b><br><b>6CT2SB*</b><br><b>6CT2SN*</b> | <b>Flush Style Cover Assembly</b> - Low profile cover designed to attach to the 2 and 4-gang RFBA round activation floor boxes. Each cover is made from die-cast aluminum materials and equipped with a durable hinge which allows the cover to rotate open 180°, two (2) slide egress doors that lock in the open position and auto-close around the cables when the covers are closed. These covers are designed to sit flush with finished floor covers such as: carpet, tile, and wood. Available in three (3) aesthetic powder coated finishes: black (BK), gray (GY), bronze (BZ) and three durable finishes: brushed aluminum (AA), satin brass plated (SB), and satin nickel plated (SN). | <b>Powder Coat Finishes</b><br><b>6CT2BKTR</b><br><b>6CT2GYTR</b><br><b>6CT2BZTR</b><br><br><b>Durable Finishes</b><br><b>6CT2AATR*</b><br><b>6CT2SBTR*</b><br><b>6CT2SNTR*</b> | <b>Tamper-Resistant Flush Style Cover Assembly</b> - Low profile cover designed to attach to the 2 and 4-gang RFBA round activation floor boxes. Each cover is made from die-cast aluminum materials and equipped with a tamper-resistant screw to keep out unauthorized personnel, a durable hinge which allows the cover to rotate open 180°, two (2) slide egress doors that lock in the open position and auto-close around the cables when the covers are closed. These covers are designed to sit flush with finished floor surfaces such as: carpet, tile, wood, polished concrete, and terrazzo. Available in three (3) aesthetic powder coated finishes: black (BK), gray (GY), bronze (BZ) and three durable finishes: brushed aluminum (AA), satin brass plated (SB), and satin nickel plated (SN). |

**\*NOTE:** Durable finishes are available as BAA product with -NA suffix.

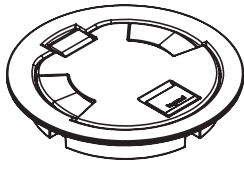

**\*NOTE:** Durable finishes are available as BAA product with -NA suffix.

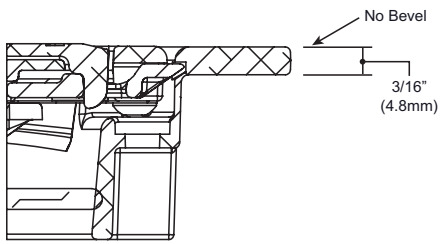
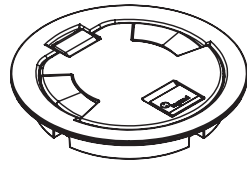

NOTE: INCLUDED 6TS TILE SHIM

**NOTE:** Pricing varies depending on country of origin. Consult your local sales representative for more information.

**Evolution Series 8" Cover Assemblies Ordering Information - Use with 6 and 10-Gangs RFBAC**

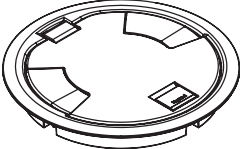
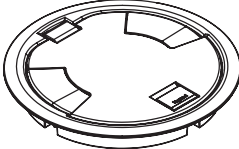
| Catalog No./Item   | Description/Specifications   | Catalog No./Item  | Description/Specifications  |
|--|--|---|---|
| <p><b>Powder Coat Finishes</b><br/>8CTC2BK<br/>8CTC2GY<br/>8CTC2BZ</p> <p><b>Durable Finishes</b><br/>8CTC2AA*<br/>8CTC2SB*<br/>8CTC2SN*</p> <p><b>*NOTE:</b> Durable finishes are available as BAA product with -NA suffix.</p>  | <p><b>Surface Style Cover Assembly</b> - Low profile cover designed to attach to the 6 and 10-gang RFBA round activation floor boxes. Each cover is made from die-cast aluminum materials and equipped with a durable hinge which allows the cover to rotate open 180°, two (2) slide egress doors that lock in the open position and auto-close around the cables when the covers are closed, and an 8° beveled edge that meets ADA guidelines and reduces tripping hazards. These covers are designed to sit on top of finished floor surfaces such as: carpet, tile, wood, polished concrete, and terrazzo. Available in three (3) aesthetic powder coated finishes: black (BK), gray (GY), bronze (BZ) and three durable finishes: brushed aluminum (AA), satin brass plated (SB), and satin nickel plated (SN).</p> | <p><b>Powder Coat Finishes</b><br/>8CTC2BKTR<br/>8CTC2GYTR<br/>8CTC2BZTR</p> <p><b>Durable Finishes</b><br/>8CTC2AATR*<br/>8CTC2SBTR*<br/>8CTC2SNTR*</p> <p><b>*NOTE:</b> Durable finishes are available as BAA product with -NA suffix.</p>  | <p><b>Tamper-Resistant Surface Style Cover Assembly</b> - Low profile cover designed to attach to the 6 and 10-gang RFBA round activation floor boxes. Each cover is made from die-cast aluminum materials and equipped with a durable hinge which allows the cover to rotate open 180°, two (2) slide egress doors that lock in the open position and auto-close around the cables when the covers are closed, and an 8° beveled edge that meets ADA guidelines and reduces tripping hazards. These covers are designed to sit on top of finished floor surfaces such as: carpet, tile, wood, polished concrete, and terrazzo. Available in three (3) aesthetic powder coated finishes: black (BK), gray (GY), bronze (BZ) and three durable finishes: brushed aluminum (AA), satin brass plated (SB), and satin nickel plated (SN).</p> |

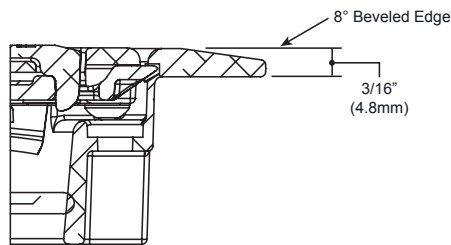

**Evolution Series 8" Cover Assemblies Ordering Information - Use with 6 and 10-Gang RFBAC**

| Catalog No./Item   | Description/Specifications   | Catalog No./Item   | Description/Specifications  |
|--|--|--|---|
| <b>8CT-CTR</b>   | <b>8" Terrazzo Ring</b> - Nonmetallic ring for use on terrazzo floor applications. Compatible with the 6 and 10-gang RFBA round activation floor boxes.  | <b>8TS</b>   | <b>Tile Shim</b> - Used for floor coverings greater than 3/16" (4.8mm). The 8TS will allow the top surface of the cover to be flush with the finished floor. Includes: six (6) 1/16" (1.6mm) thick sjims. Up to a total of 3/8" (9.5mm) of adjustment.  |
| <b>Powder Coat Finishes</b><br>8CT2BK<br>8CT2GY<br>8CT2BZ                    | <b>Flush Style Cover Assembly</b> - Low profile cover designed to attach to the 6 and 10-gang RFBA round activation floor boxes. Each cover is made from die-cast aluminum materials and equipped with a durable hinge which allows the cover to rotate open 180°, two (2) slide egress doors that lock in the open position and auto-close around the cables when the covers are closed. These covers are designed to sit flush with finished floor covers such as: carpet, tile, and wood. Available in three (3) aesthetic powder coated finishes: black (BK), gray (GY), bronze (BZ) and three durable finishes: brushed aluminum (AA), satin brass plated (SB), and satin nickel plated (SN). | <b>Powder Coat Finishes</b><br>8CT2BKTR<br>8CT2GYTR<br>8CT2BZTR              | <b>Tamper-Resistant Flush Style Cover Assembly</b> - Low profile cover designed to attach to the 6 and 10-gang RFBA round activation floor boxes. Each cover is made from die-cast aluminum materials and equipped with a tamper-resistant screw to keep out unauthorized personnel, a durable hinge which allows the cover to rotate open 180°, two (2) slide egress doors that lock in the open position and auto-close around the cables when the covers are closed. These covers are designed to sit flush with finished floor surfaces such as: carpet, tile, wood, polished concrete, and terrazzo. Available in three (3) aesthetic powder coated finishes: black (BK), gray (GY), bronze (BZ) and three durable finishes: brushed aluminum (AA), satin brass plated (SB), and satin nickel plated (SN). |
| <b>Durable Finishes</b><br>8CT2AA*<br>8CT2SB*<br>8CT2SN*                     |  | <b>Durable Finishes</b><br>8CT2AATR*<br>8CT2SBTR*<br>8CT2SNTR*               |   |
| <b>*NOTE:</b> Durable finishes are available as BAA product with -NA suffix. |  | <b>*NOTE:</b> Durable finishes are available as BAA product with -NA suffix. |   |

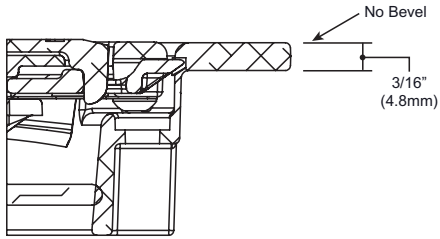

NOTE: INCLUDED 8TS TILE SHIM

**NOTE: All brand and product names referenced in this document are registered trademarks or trademarks of their respective holders.**